

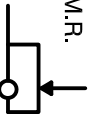

**VW TIGUAN  
SKODA KODIAQ  
AUDI Q3**

|   |  |  |
|---|--|--|
| M.M.R.<br> | S<br> | D<br> |
| 2.500 kg.   | 100 kg.  | 12,62 kN   |



ECE R55  
homologación

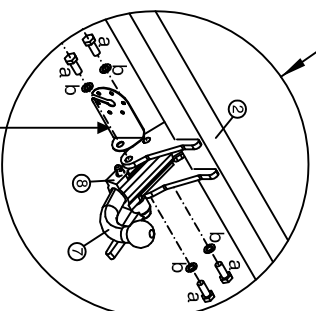
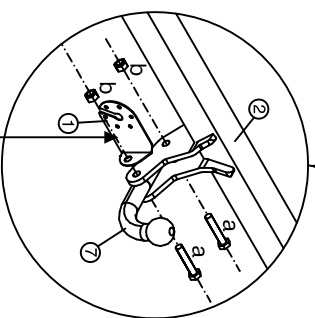
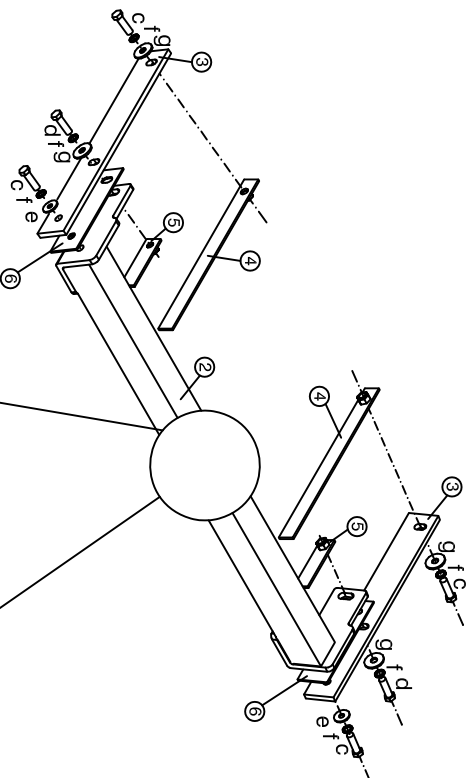

Made by LAFUENTE (SPAIN)  
 Nº TI. (S) 903 023 560  
 www.lafuente.es









**E9** 5SR - 01 2234

TIPO: EEO499 D: 12,62 kN  
 CLASE: A-50X S: 100 kg

Made by LAFUENTE (SPAIN)  
 Nº TI. (S) 903 023 560  
 www.lafuente.es

**E9** 5SR - 01 2235

TIPO: EE1499 D: 12,62 kN  
 CLASE: A-50X S: 100 kg

| ELEMENTOS DE UNIÓN / CONNECTION COMPONENTS<br>DAZUGEHÖRENDEN TEILEN / ÉLÉMENTS DE RACCORD |  | VEHÍCULO / VEHICLE<br>FAHRZEUG / VÉHICULE |  |
|---|--|---|--|
| BOLA / BALL / KUGEL / BOULE   |  |   |  |
| a   | 2 x  M12x65 DIN 931 | 8,8                                       | c  4 x M12x50 DIN 933 |
| b   | 2 x  M12 DIN 985     | 8   | d  2 x M12x60 DIN 931 |
| a   | 4 x  M12x25 DIN 933   | 8,8                                       | e  2 x M12 DIN 125    |
| b   | 4 x  M12 DIN 127      | -   | f  6 x M12 DIN 6798    |
|   |  |   | g  4 x M12 DIN 9021     |

Par de apriete para los tornillos/Tightening torque for bolts/Schrauben Drehmoment/Couple de serrage pour vis

| Und.Nm  | M6   | M8   | M10  | M12  | M14   | M16   |
|---------|------|------|------|------|-------|-------|
| calibre | 1    | 1,25 | 1,5  | 1,25 | 1,75  | 1,5   |
| peso    | 11,3 | 27,3 | 54,0 | 57,0 | 93,0  | 97,0  |
|         | 10,9 | 16,5 | 40,1 | 79,0 | 83,0  | 143,0 |
|         | 12,9 | 19,3 | 46,9 | 93,0 | 98,0  | 167,0 |
|         |      |      |      |      | 160,0 | 174,0 |
|         |      |      |      |      | 255,0 | 274,0 |
|         |      |      |      |      | 148,0 | 159,0 |
|         |      |      |      |      | 218,0 | 234,0 |
|         |      |      |      |      | 255,0 | 320,0 |
|         |      |      |      |      | 274,0 | 395,0 |

Este documento debe ser presentado en la I.T.V. junto con el certificado de montaje.  
 HNOS.SANCHEZ-LAFUENTE,S.A. no asume ningún tipo de responsabilidad por  
 daños causados por usos inadecuados.



EE0499



EE1499

# AUDI Q3

# VW TIGUAN II

# SKODA KODIAQ

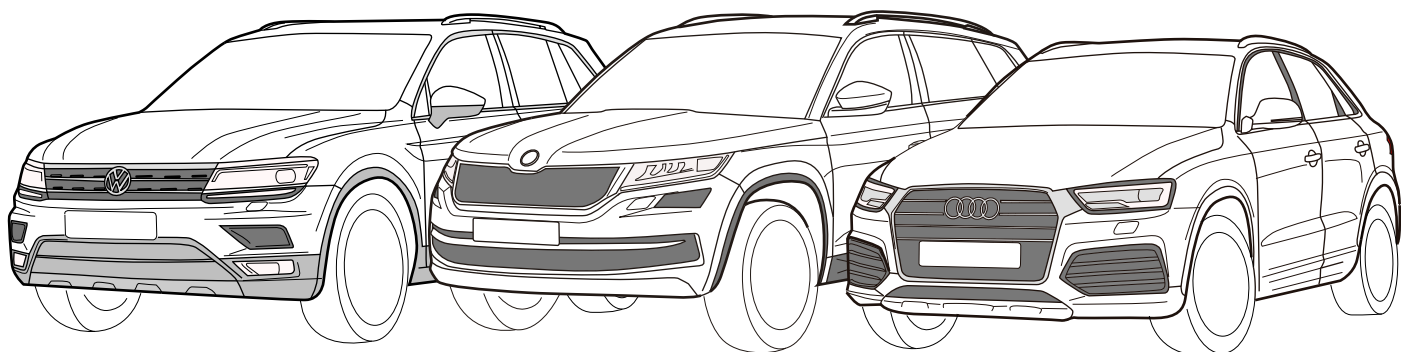

Instrucciones de montaje - Installation instructions - Notice de montage - Montage- og driftsvejledning

1

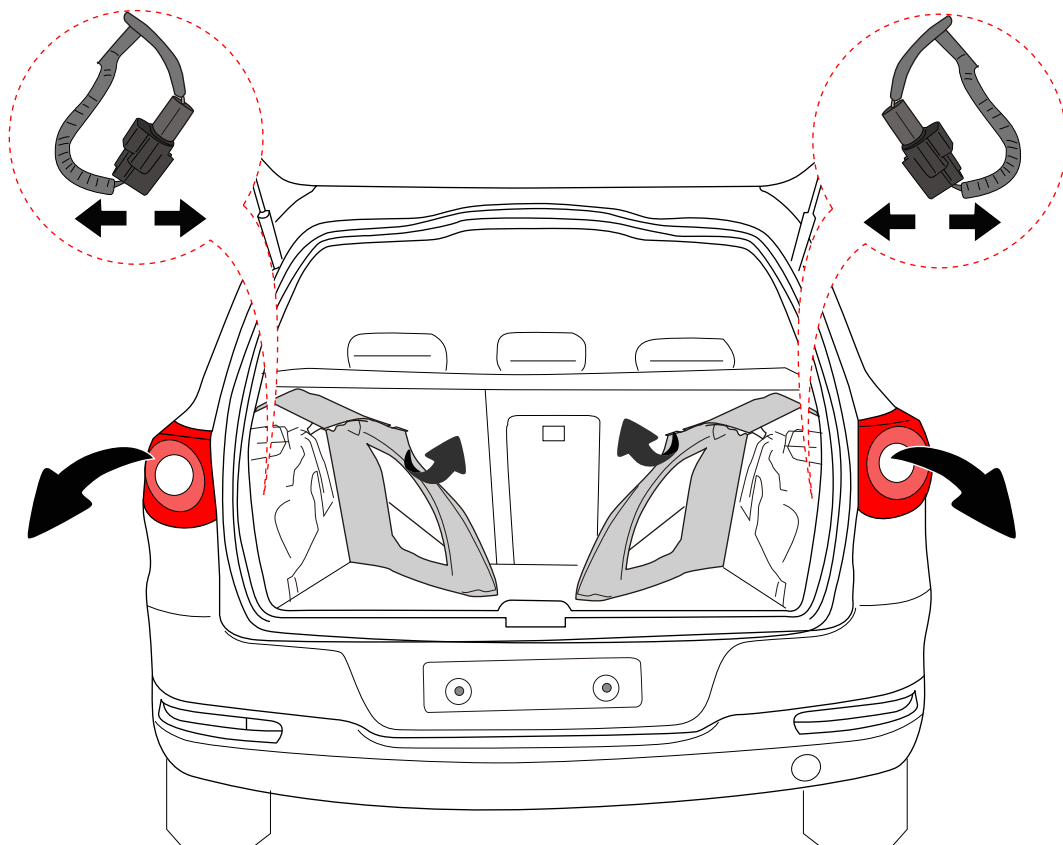

2

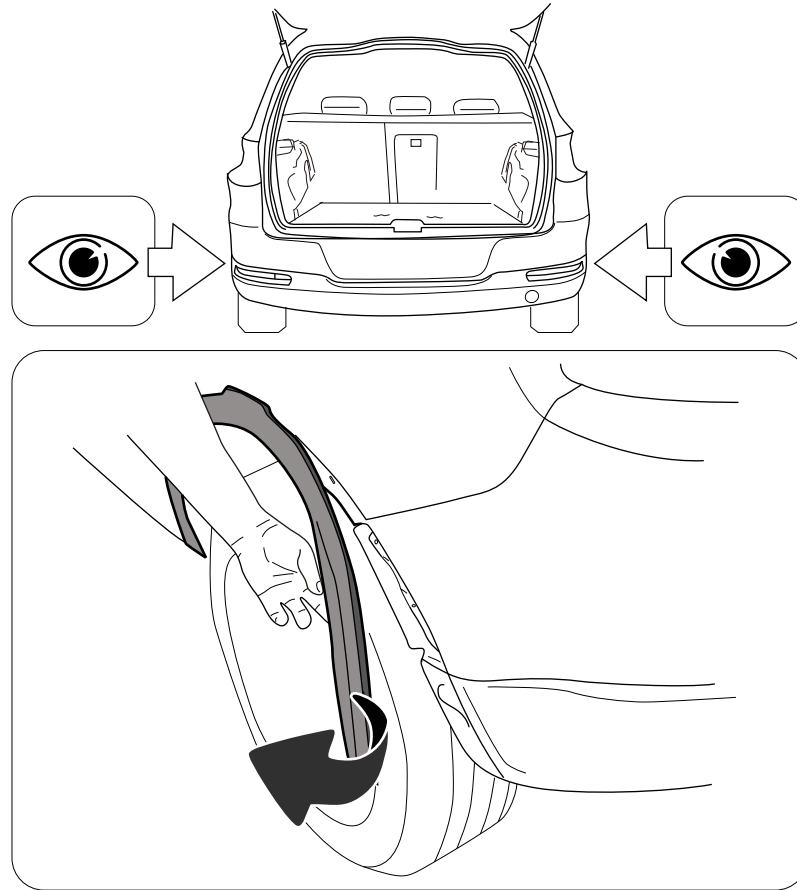

3

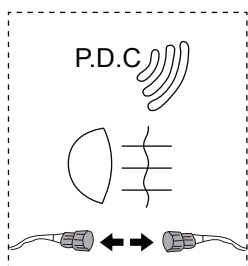
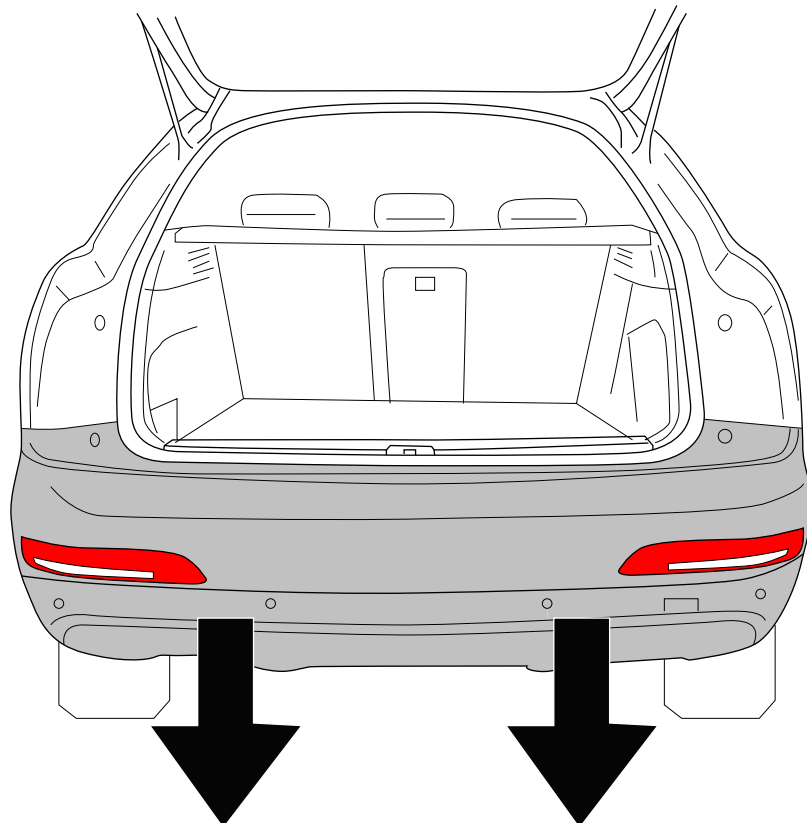

4

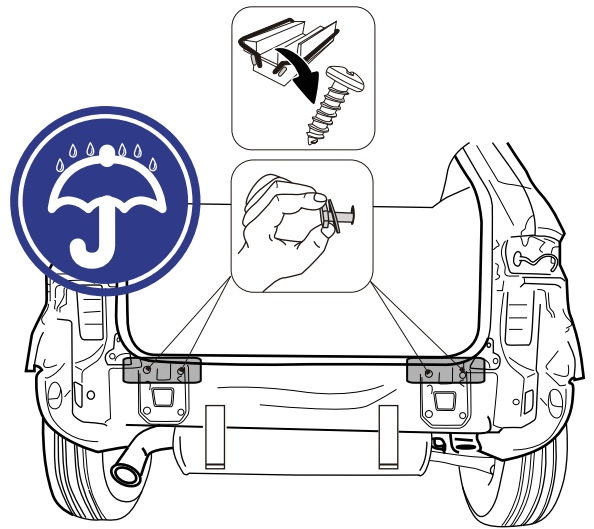
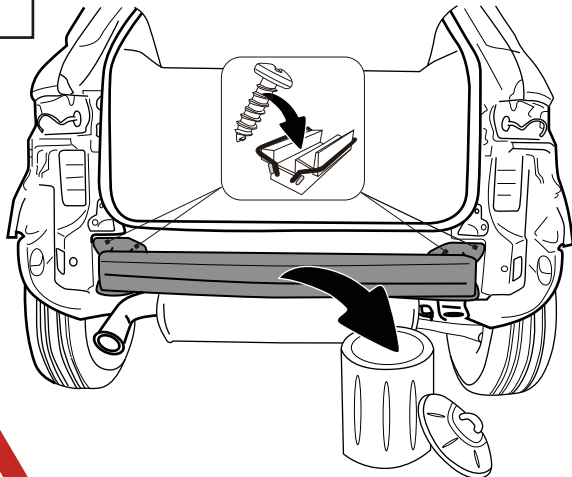

SKODIA KODIAQ  
VW TIGUAN II  
Adblue

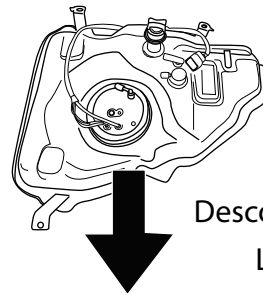
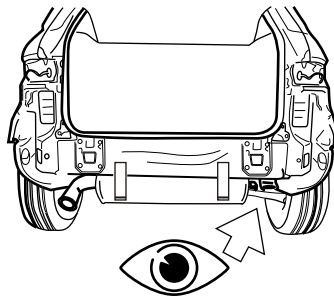

Descolgar deposito Adblue  
Lift Adblue tank

5

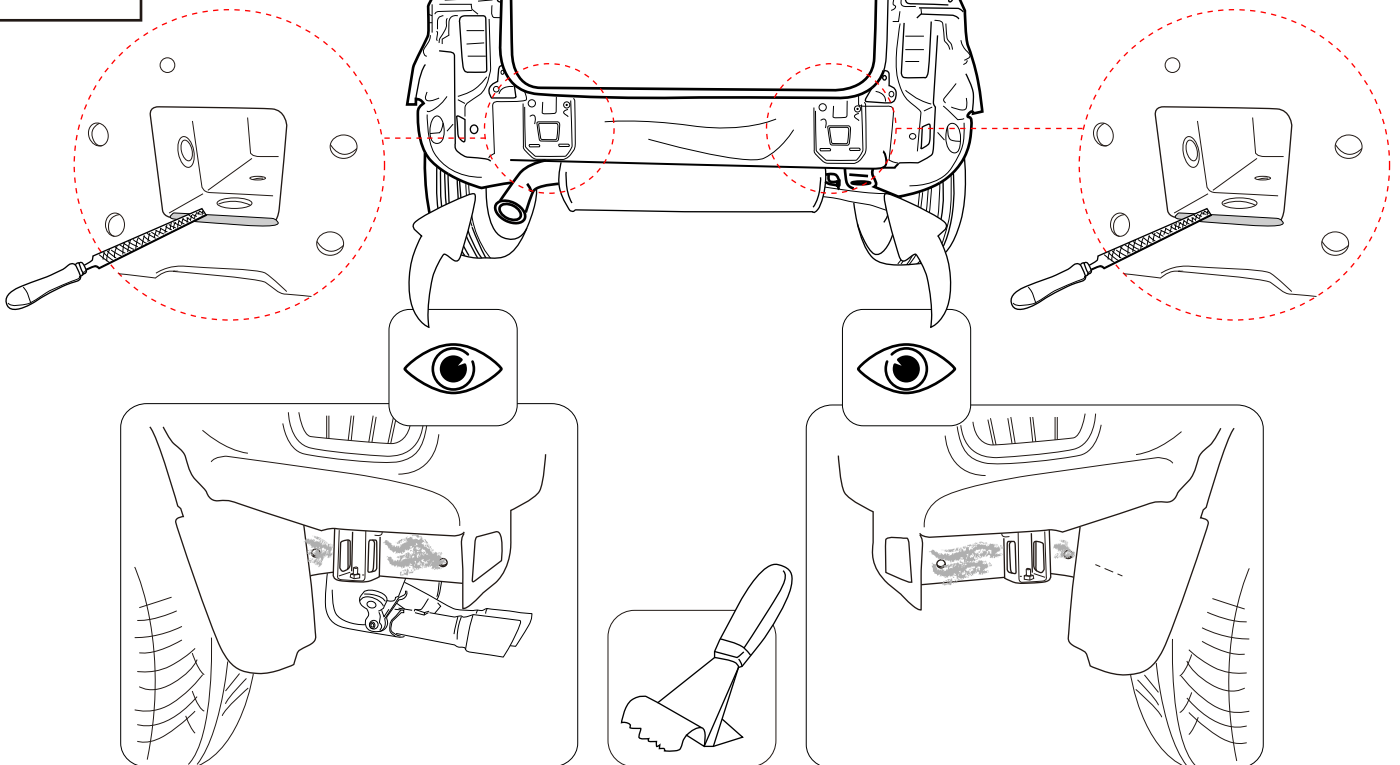

6

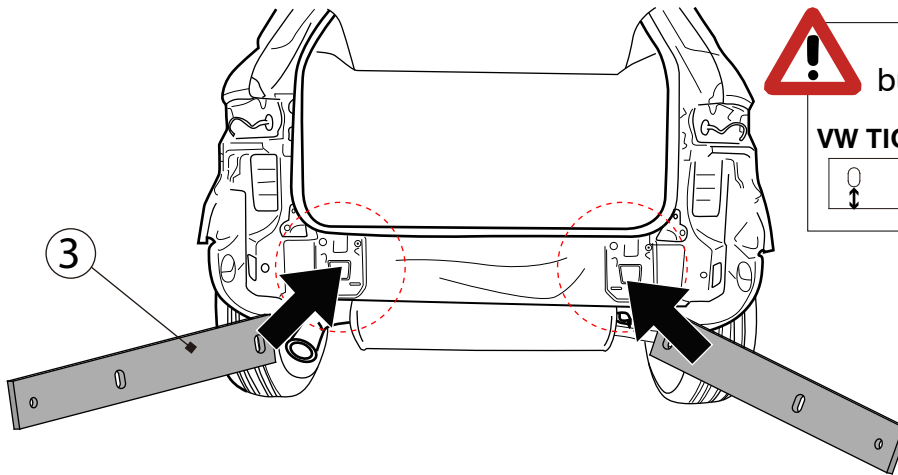

colocación pieza 3  
buscar mayor distancia

VW TIGUAN II/SKODA KODIAQ

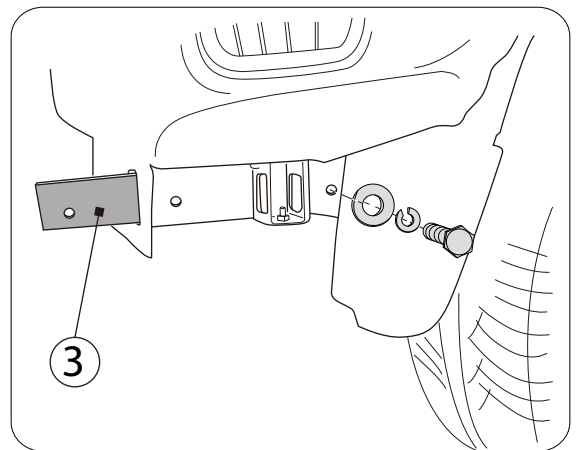
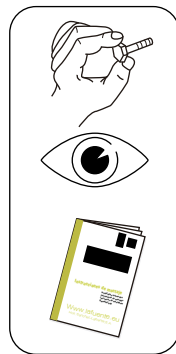
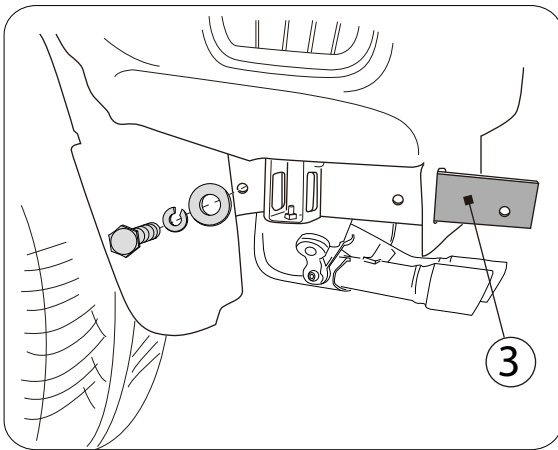

7

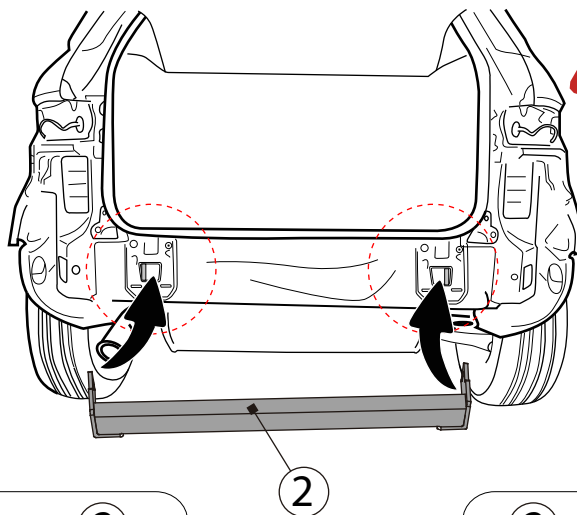
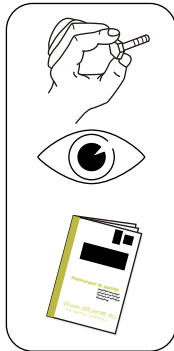

En algunos modelos  
necesita colocar pieza 6

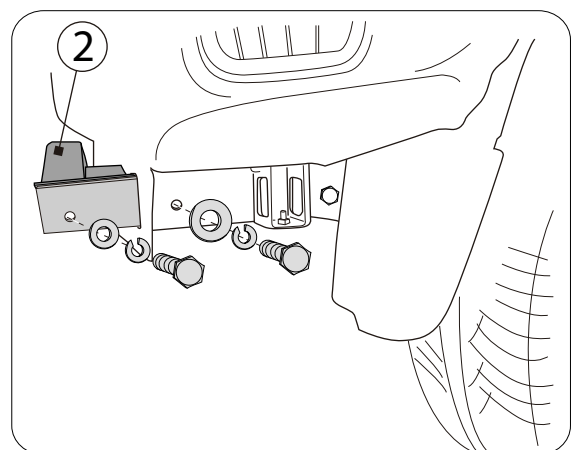
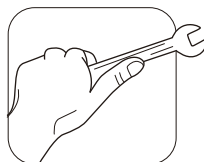
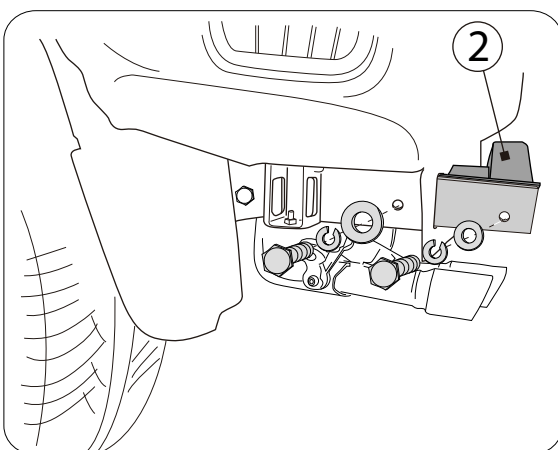
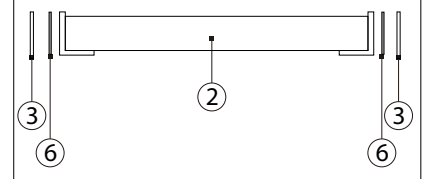

8

SKODA KODIAQ VW TIGUAN II

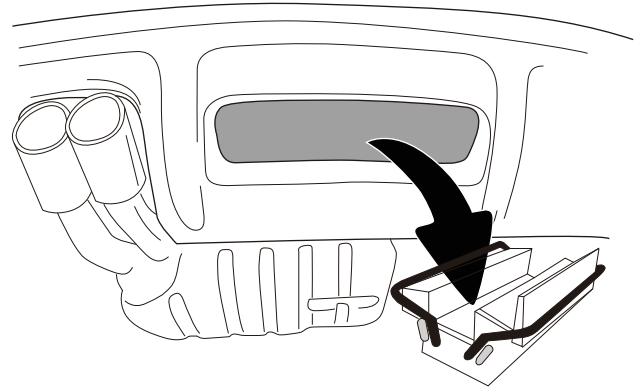
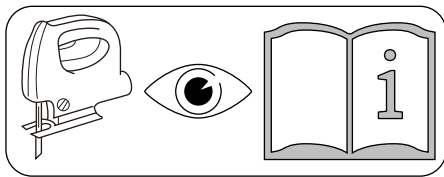
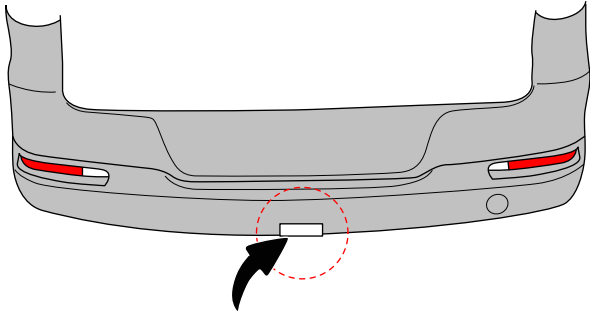

9

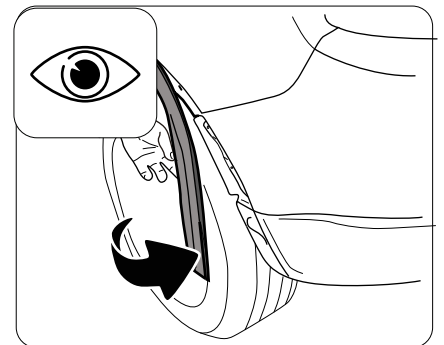
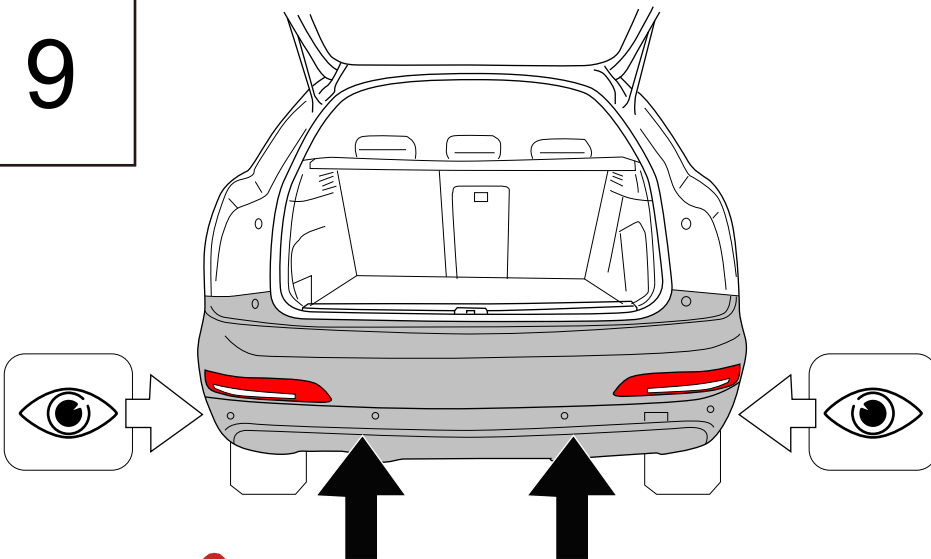

SKODIA KODIAQ  
VW TIGUAN II  
Adblue

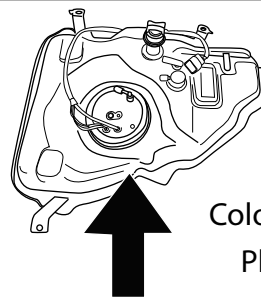
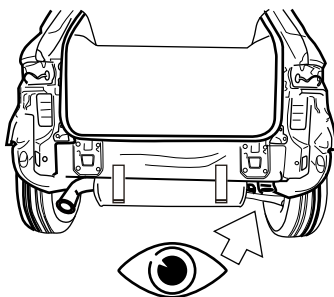

Colocar deposito Adblue  
Place Adblue tank

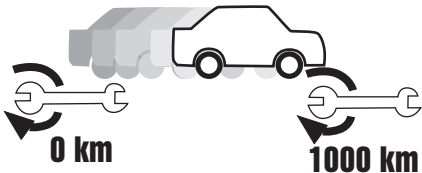
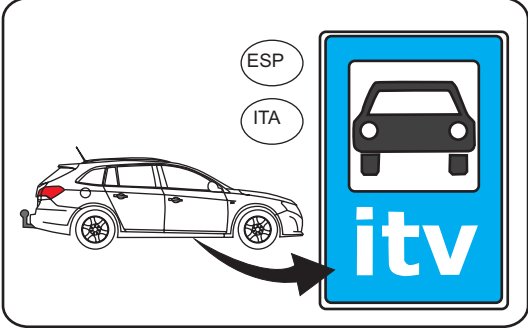
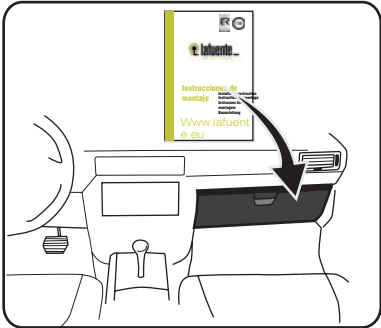
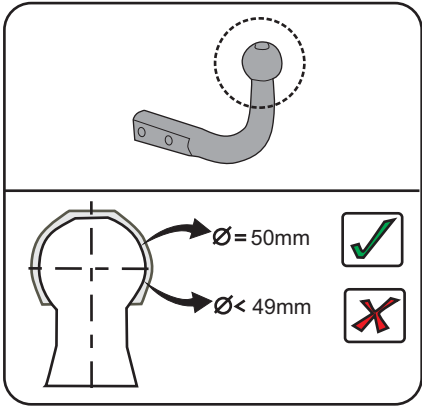
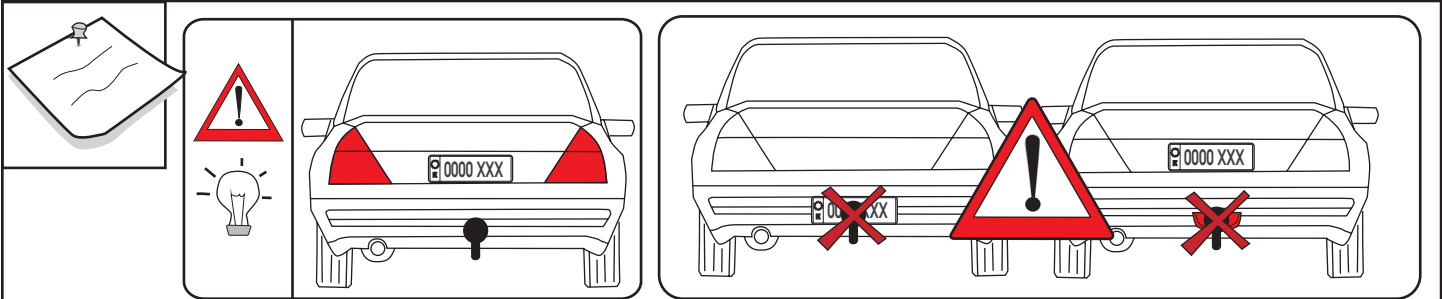
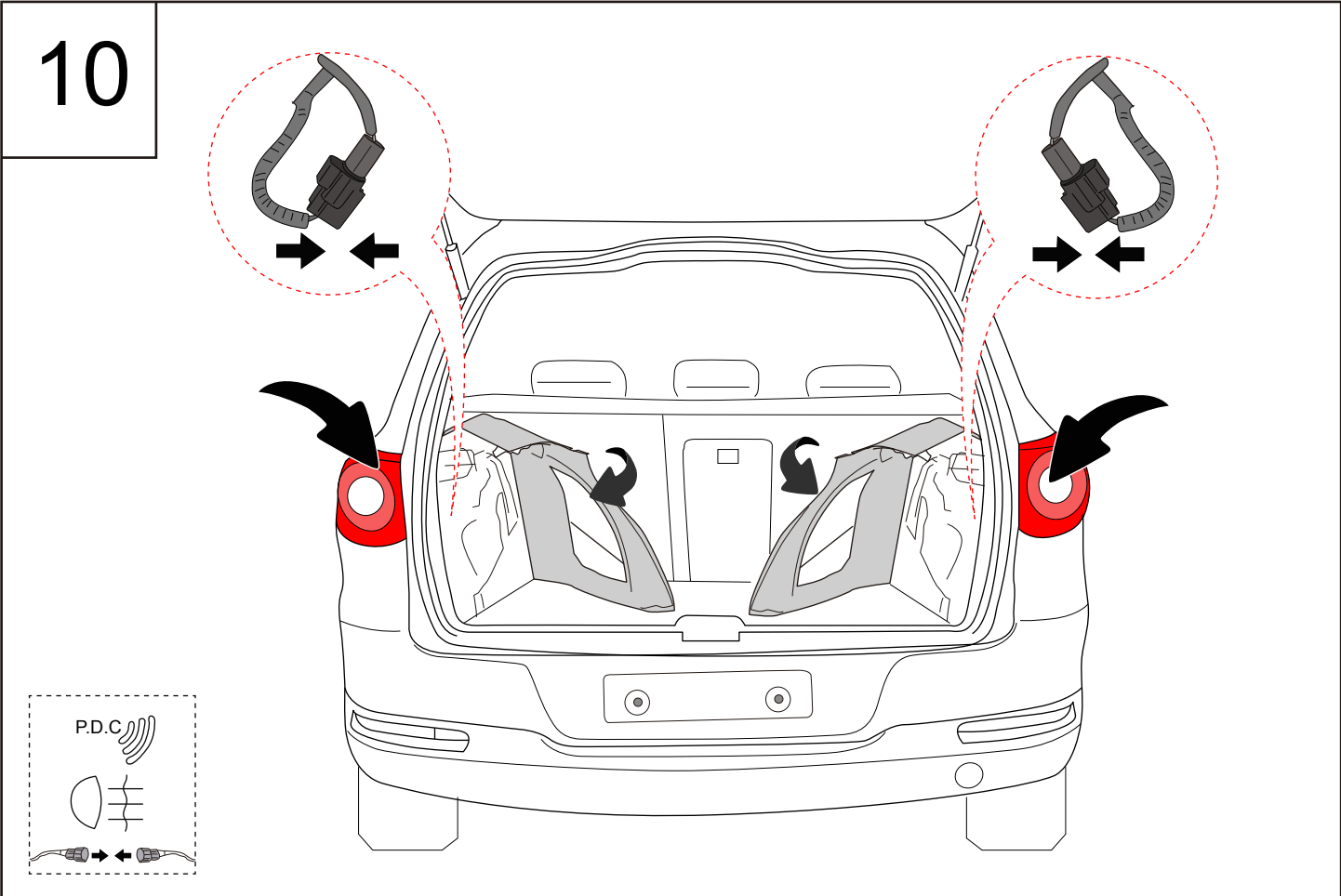

|      | M6     | M8     | M10    | M12     | M14     | M16     |
|------|--------|--------|--------|---------|---------|---------|
| 8.8  | 10,4Nm | 25,0Nm | 51,0Nm | 87,0Nm  | 140,0Nm | 215,0Nm |
| 10.9 | 15,5Nm | 37,0Nm | 75,0Nm | 130,0Nm | 205,0Nm | 310,0Nm |
| 12.9 | 18,0Nm | 43,0Nm | 87,0Nm | 150,0Nm | 240,0Nm | 370,0Nm |