

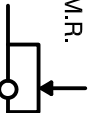

PEUGEOT 207+207CC+208
CITROËN C3 PICASSO
CITROËN C4 CACTUS
CITROËN C3

M.M.R.	S	D
		
1.400 kg.	80 kg.	7.53 kN



ECE R55
homologación

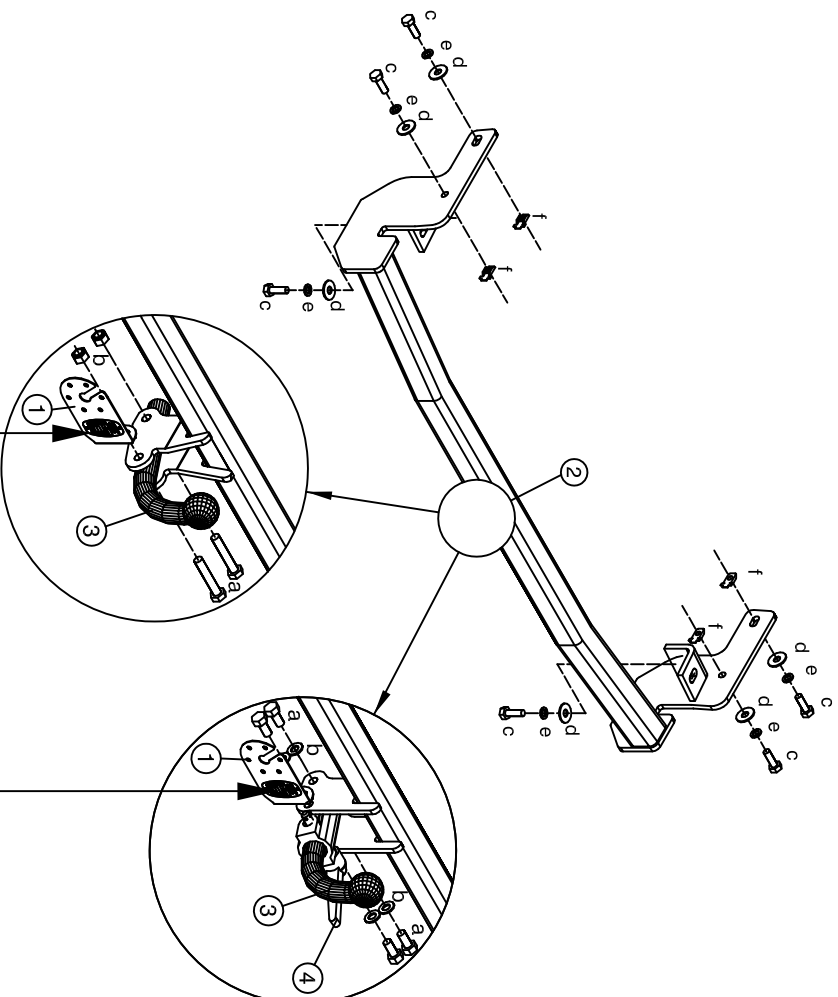

Made by LAFUENTE
SPAIN
Tlf. (+34) 952 625 940
www.lafuente.eu

E9 55R - 01 2003

TIPO EE0424 D 7,53 kN

CLASE A-50X S 80 kg

Extension No.:01









Made by LAFUENTE
SPAIN
Tlf. (+34) 952 625 940
www.lafuente.eu

E9 55R - 01 2004

TIPO EE1424 D 7,53 kN

CLASE A-50X S 80 kg

Extension No.:01

ELEMENTOS DE UNIÓN / CONNECTION COMPONENTS DAZUGEHÖRENDEN TEILEN / ÉLÉMENTS DE RACCORD		VEHÍCULO / VEHICLE FAHRZEUG / VÉHICULE			
BOLA / BALL / KUGEL / BOULE					
a	2 x  2 x M12x65 DIN 931	8.8	c	6 x  6 x M10x40 DIN 933	8.8
b	2 x  2 x M12 DIN 985	8	d	6 x  6 x M10 DIN 9021	-
a	4 x  4 x M12x25 DIN 933	8.8	e	6 x  6 x M10 DIN 127	-
b	4 x  4 x M12 DIN 127	-	f	4 x  4 x M10 A=44	8

Par de apriete para los tornillos/Tightening torque for bolts/Schrauben Drehmoment/Couple de serrage pour vis

Und.Nm	M6	M8	M10	M12	M14	M16
calibre	1	1,25	1,5	1,25	1,75	1,75
peso	11,3	27,3	54,0	57,0	93,0	97,0
	10,9	16,5	40,1	79,0	83,0	137,0
	12,9	19,3	46,9	93,0	98,0	160,0
					160,0	167,0
					174,0	174,0
					148,0	159,0
					218,0	234,0
					255,0	274,0
						320,0
						395,0

Este documento debe ser presentado en la I.T.V. junto con el certificado de montaje.

HNOS.SANCHEZ-LAFUENTE,S.A. no asume ningún tipo de responsabilidad por daños causados por usos inadecuados.



EE0424



EE1424

PEUGEOT 207 +207 CC PEUGEOT 208 CITROEN C3 PICASSO CITROEN C4 CACTUS CITROEN C3

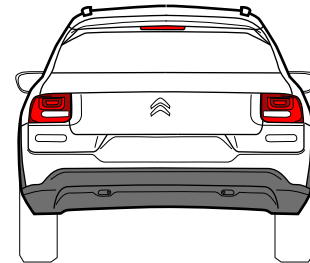
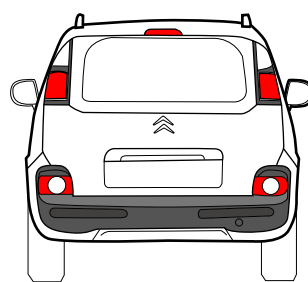
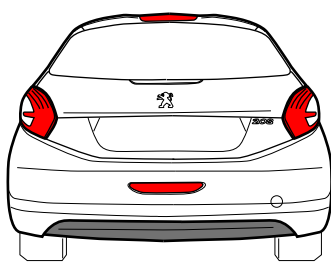
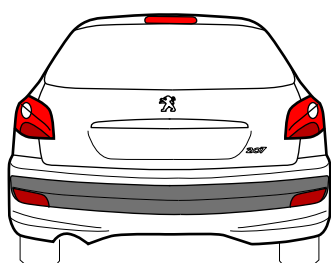

Instrucciones de montaje - Installation instructions - Notice de montage - Montage- og driftsvejledning

1

PEUGEOT 207

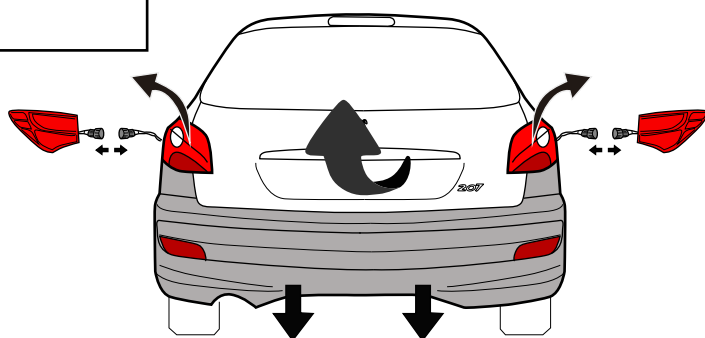

PEUGEOT 208

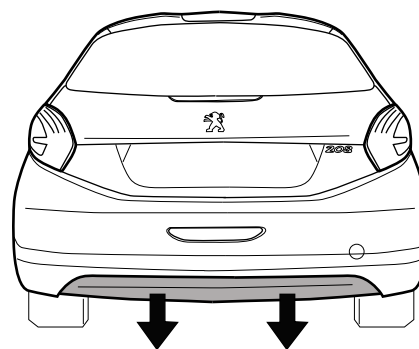

CITROEN C3 PICASSO

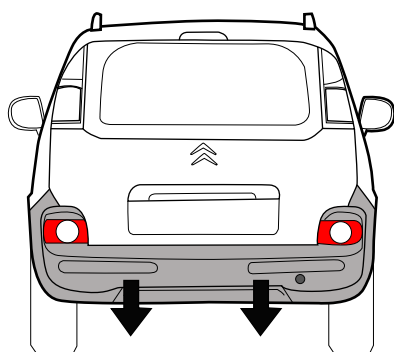

CITROEN C4 CACTUS
CITROEN C3

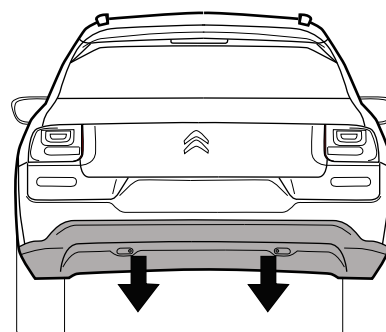

2

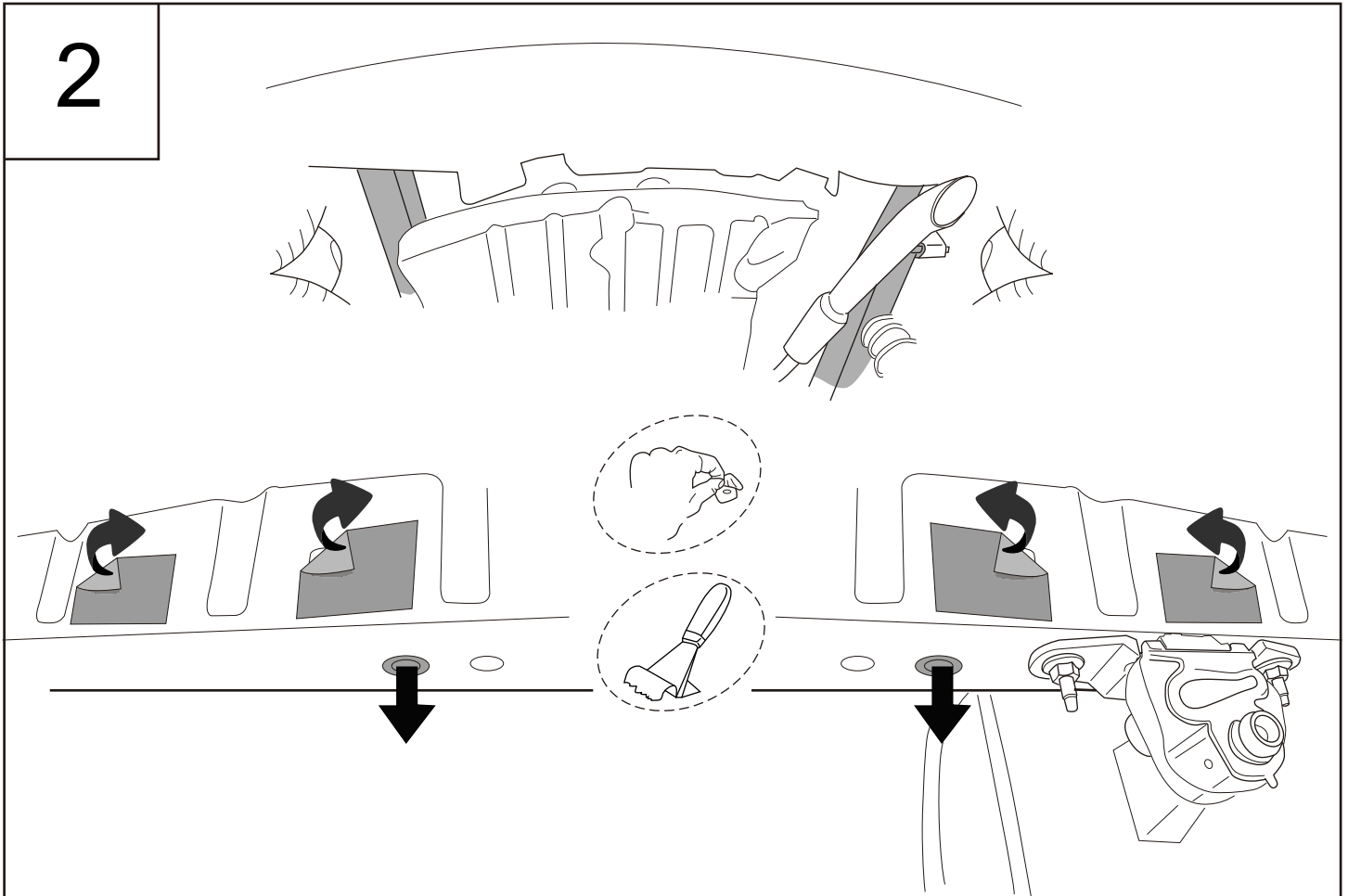

3

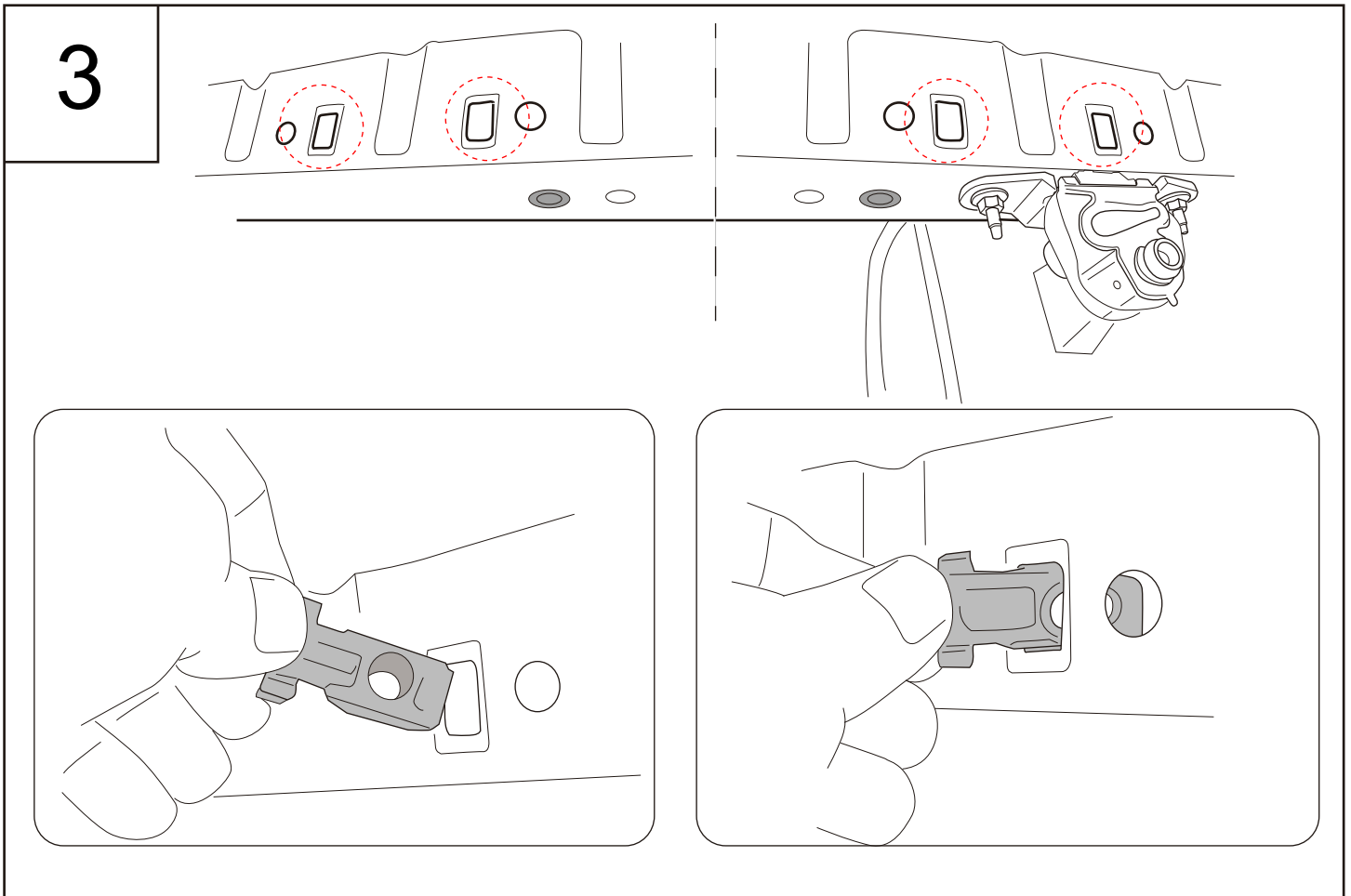

4



CITROEN C3

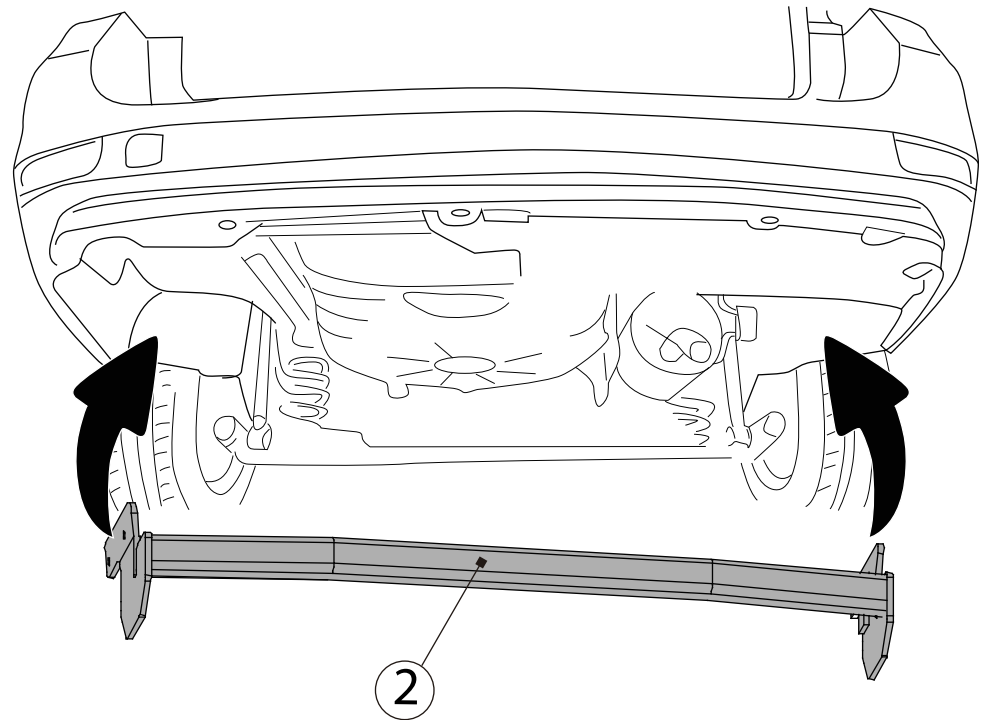
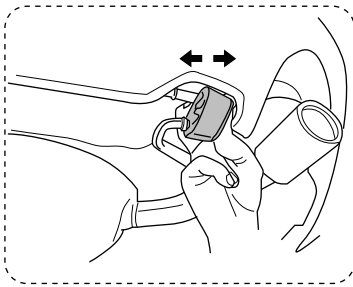

5

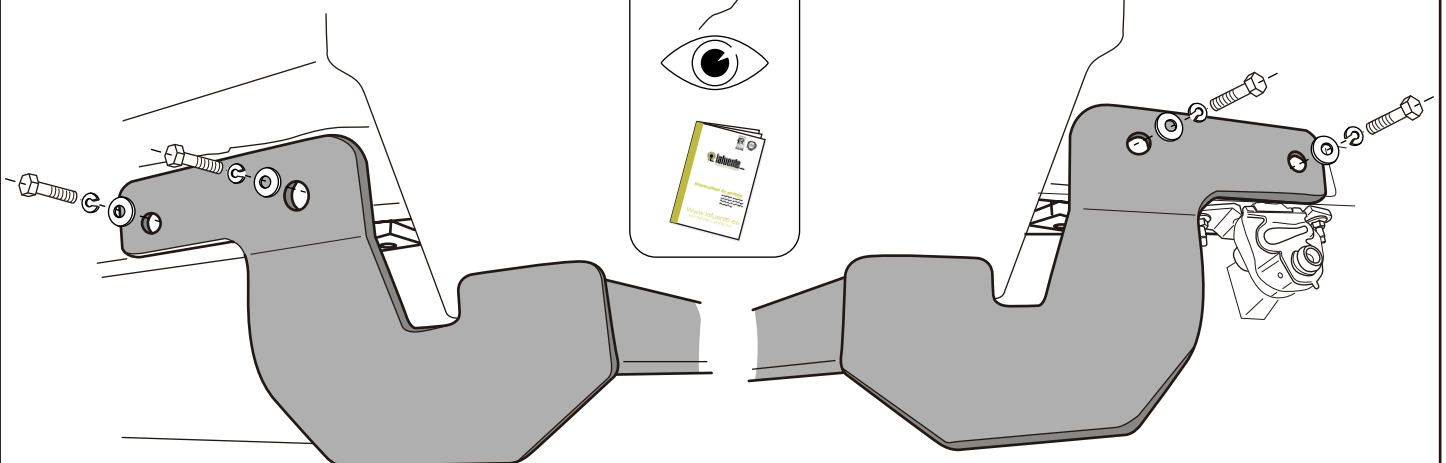

6

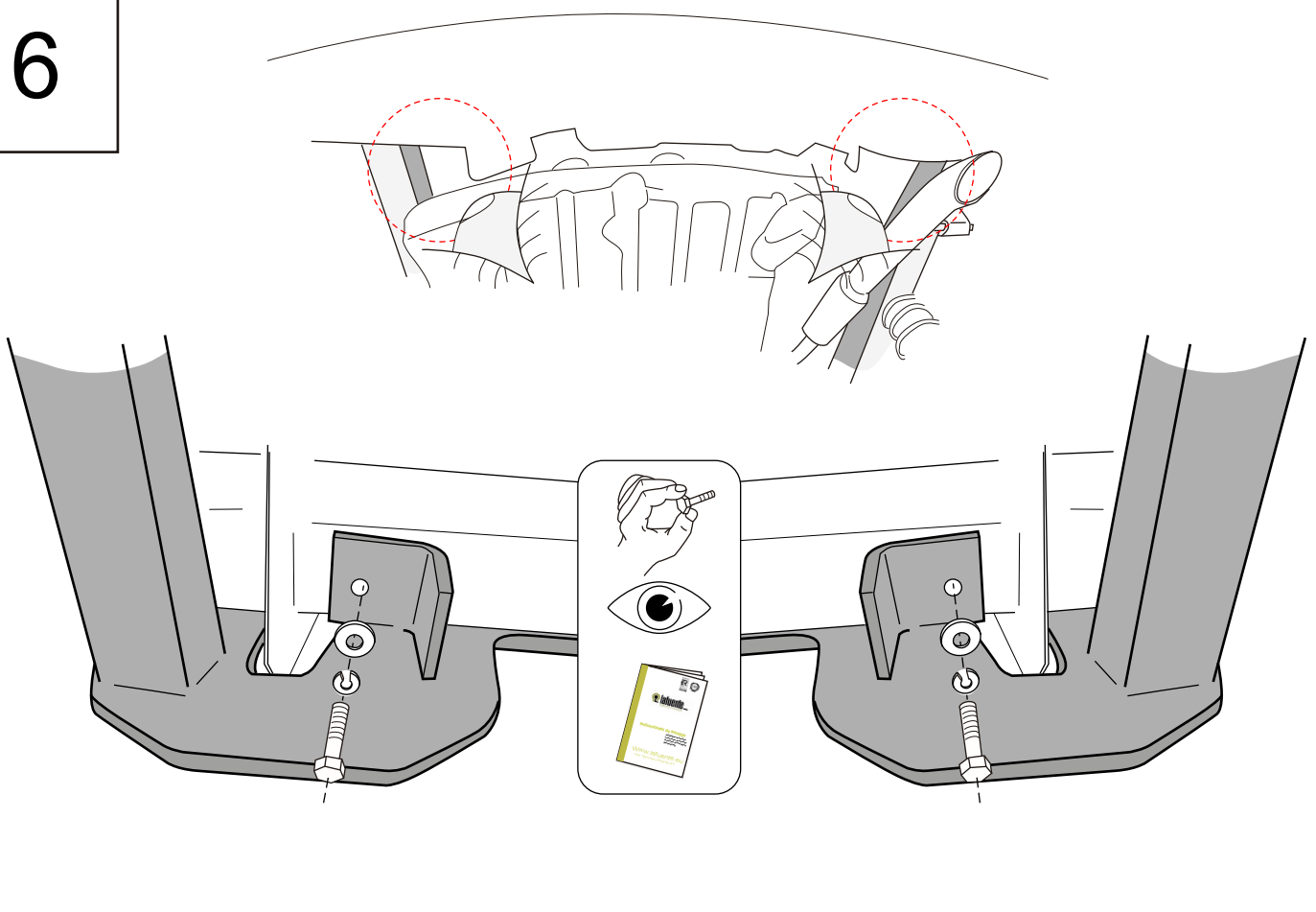

7

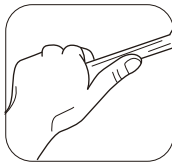

	M6	M8	M10	M12	M14	M16
8.8	10,4Nm	25,0Nm	51,0Nm	87,0Nm	140,0Nm	215,0Nm
10.9	15,5Nm	37,0Nm	75,0Nm	130,0Nm	205,0Nm	310,0Nm
12.9	18,0Nm	43,0Nm	87,0Nm	150,0Nm	240,0Nm	370,0Nm

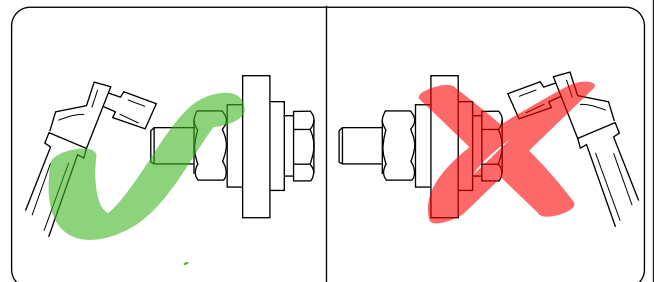
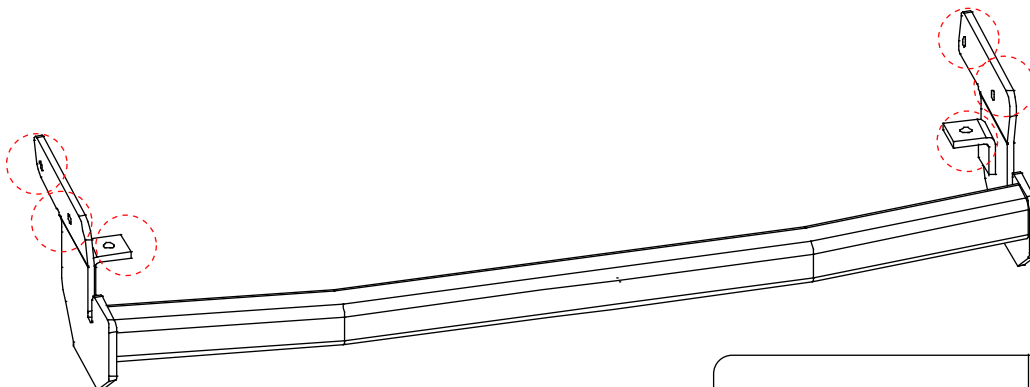

8

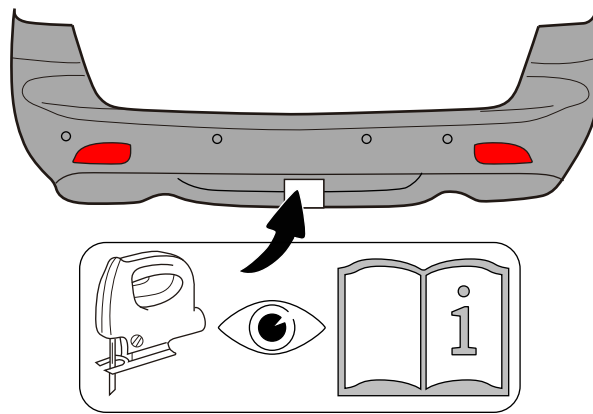

PARA ALGUNOS MODELOS NO HACE FALTA CORTAR EL PARAGOLPES

CITROEN C4 CACTUS
CITROEN C3

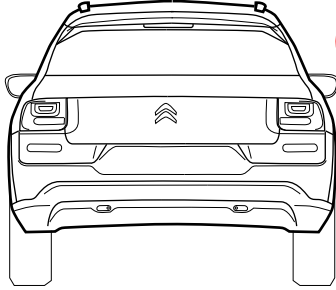

PEUGEOT 208 2012

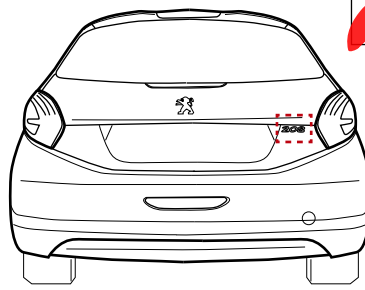

PEUGEOT 208 2015

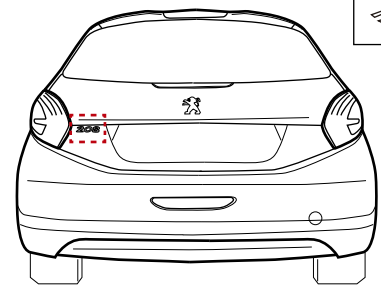

9

PEUGEOT 207

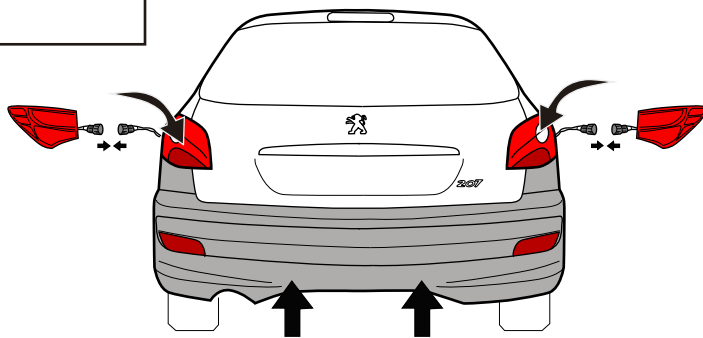

PEUGEOT 208

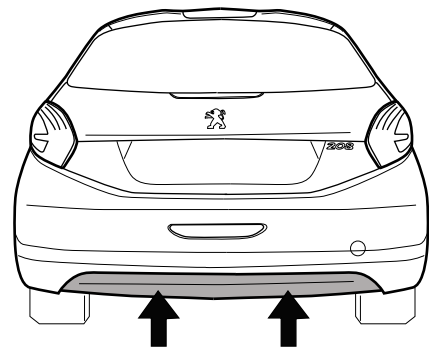

CITROEN C3 PICASSO

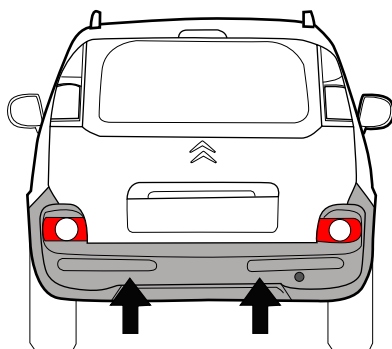

CITROEN C4 CACTUS
CITROEN C3

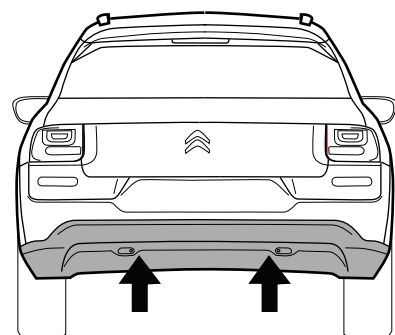

CITROEN C4 CACTUS

OFF

P

PARKING SENSOR

Quando no lleve remoque

Ø = 50mm

Ø < 49mm

ESP
ITA

0 km

1000 km

	M6	M8	M10	M12	M14	M16
8.8	10,4Nm	25,0Nm	51,0Nm	87,0Nm	140,0Nm	215,0Nm
10.9	15,5Nm	37,0Nm	75,0Nm	130,0Nm	205,0Nm	310,0Nm
12.9	18,0Nm	43,0Nm	87,0Nm	150,0Nm	240,0Nm	370,0Nm

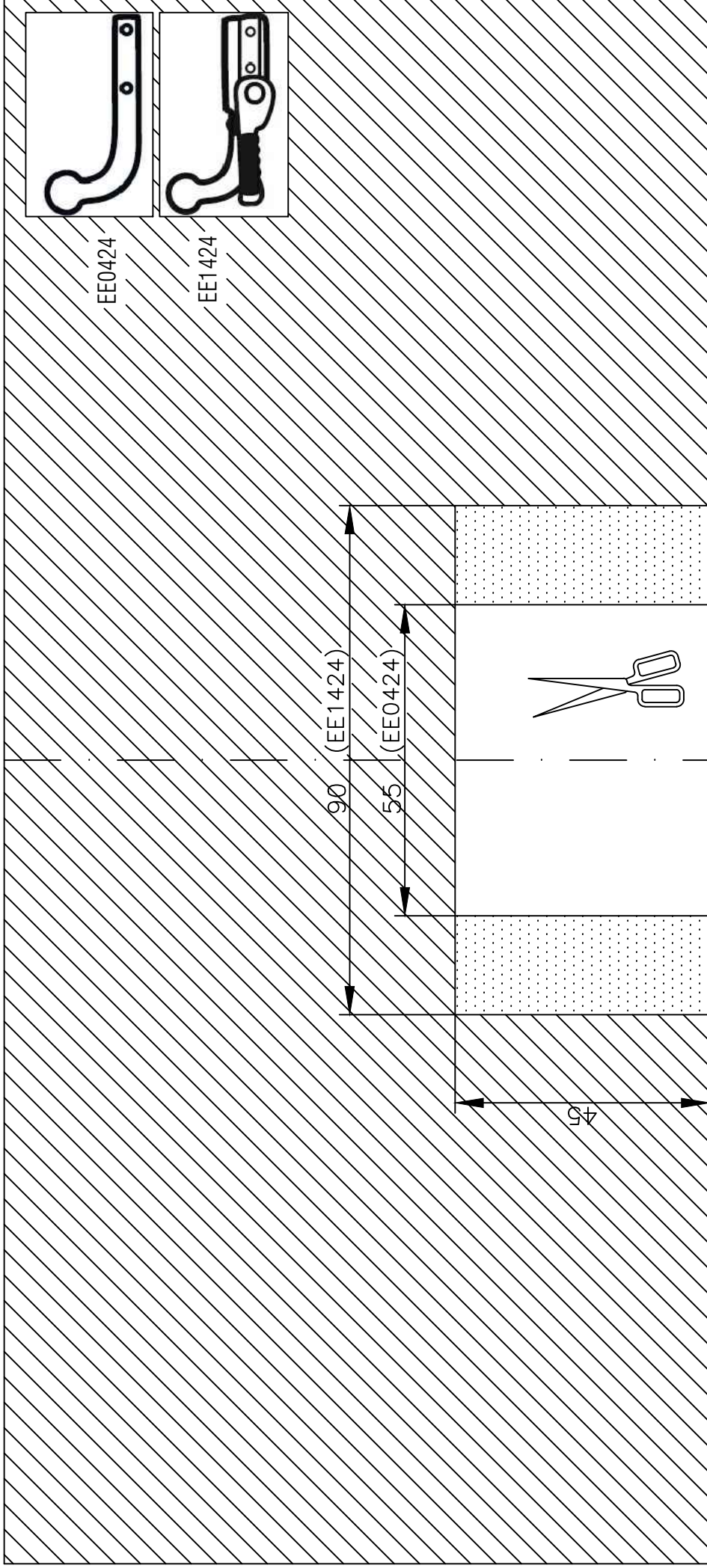

LINEA CENTRAL DEL PARAGOLPES

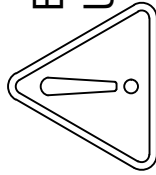

ESP: El corte es orientativo puede variar por modelo y año
 UK: The cut is indicative it can change for model and year



Dibujo: CORTE PARAGOLPES
 PEUGEOT 207

Escala:
 1:1

UNIDADES EN
 mm

EE0424-EE1424

Rev.
 P1

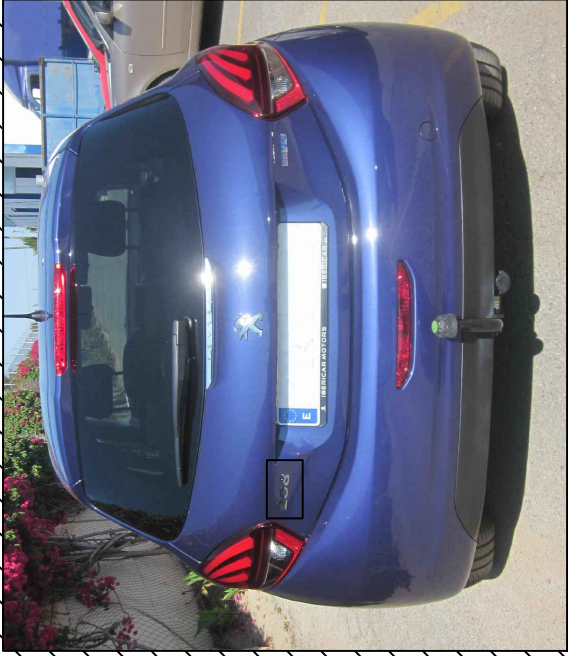

2015: el 208 a la izquierda

2016: el 208 a la derecha

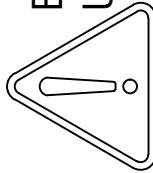
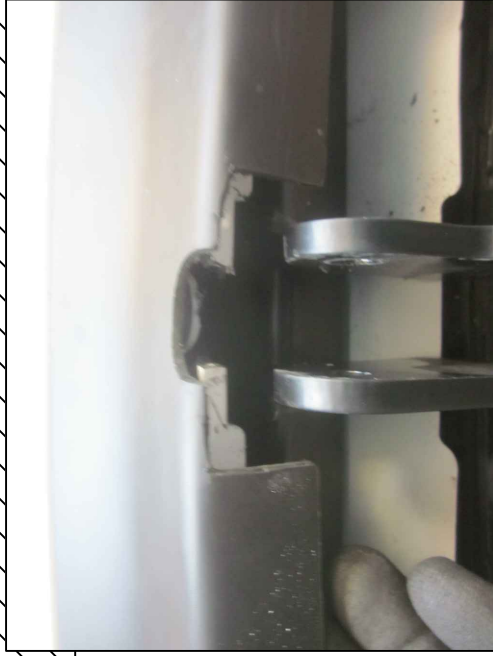

ESP: El corte es orientativo puede variar por modelo y año
 UK: The cut is indicative it can change for model and year

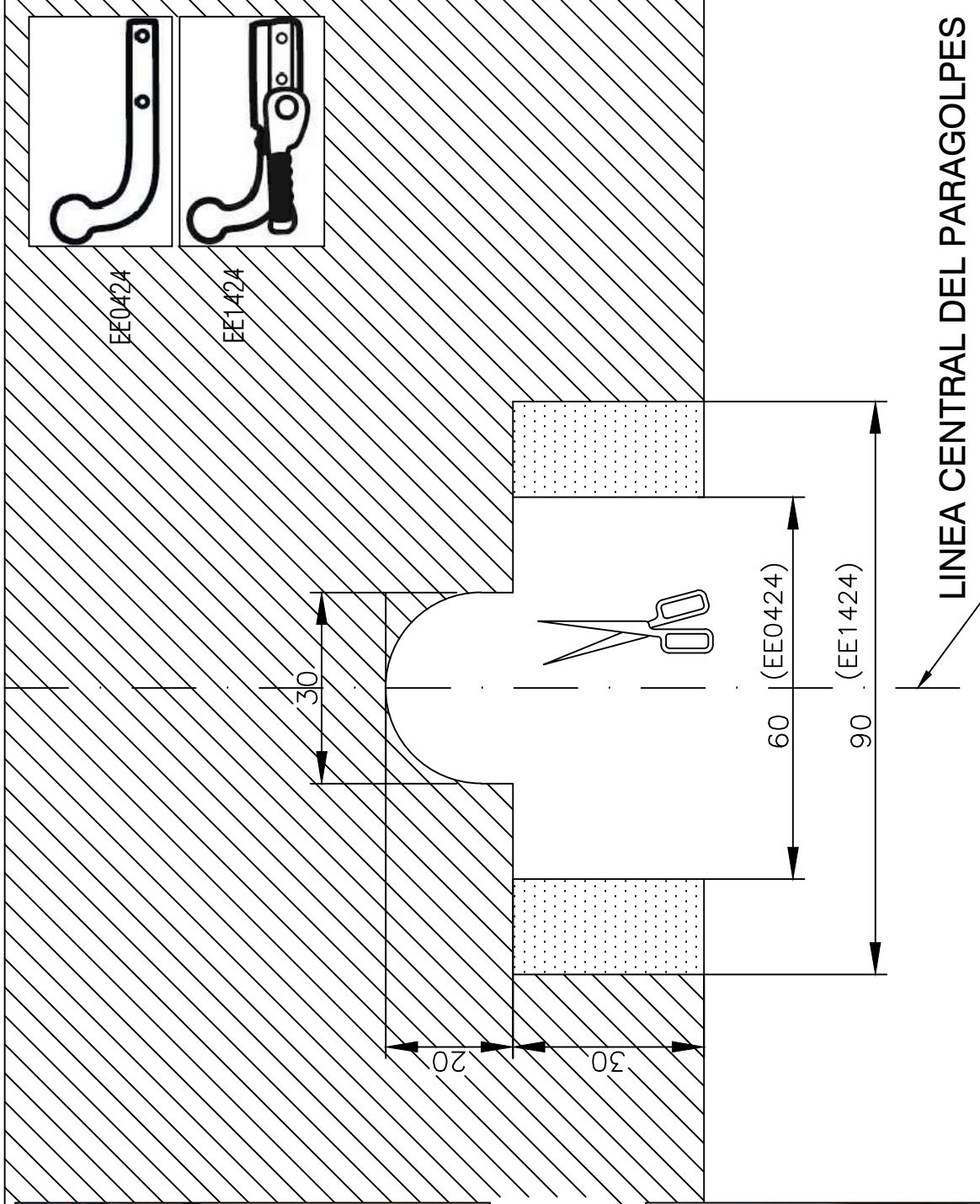

LINEA CENTRAL DEL PARAGOLPES

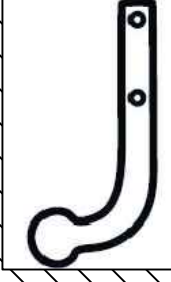

EE0424



EE1424



Dibujo:

CORTE PARAGOLPES
 PEUGEOT 208 año 2015

Escala: 1:1
 UNIDADES EN mm

Rev. P1
 EE0424-EE1424

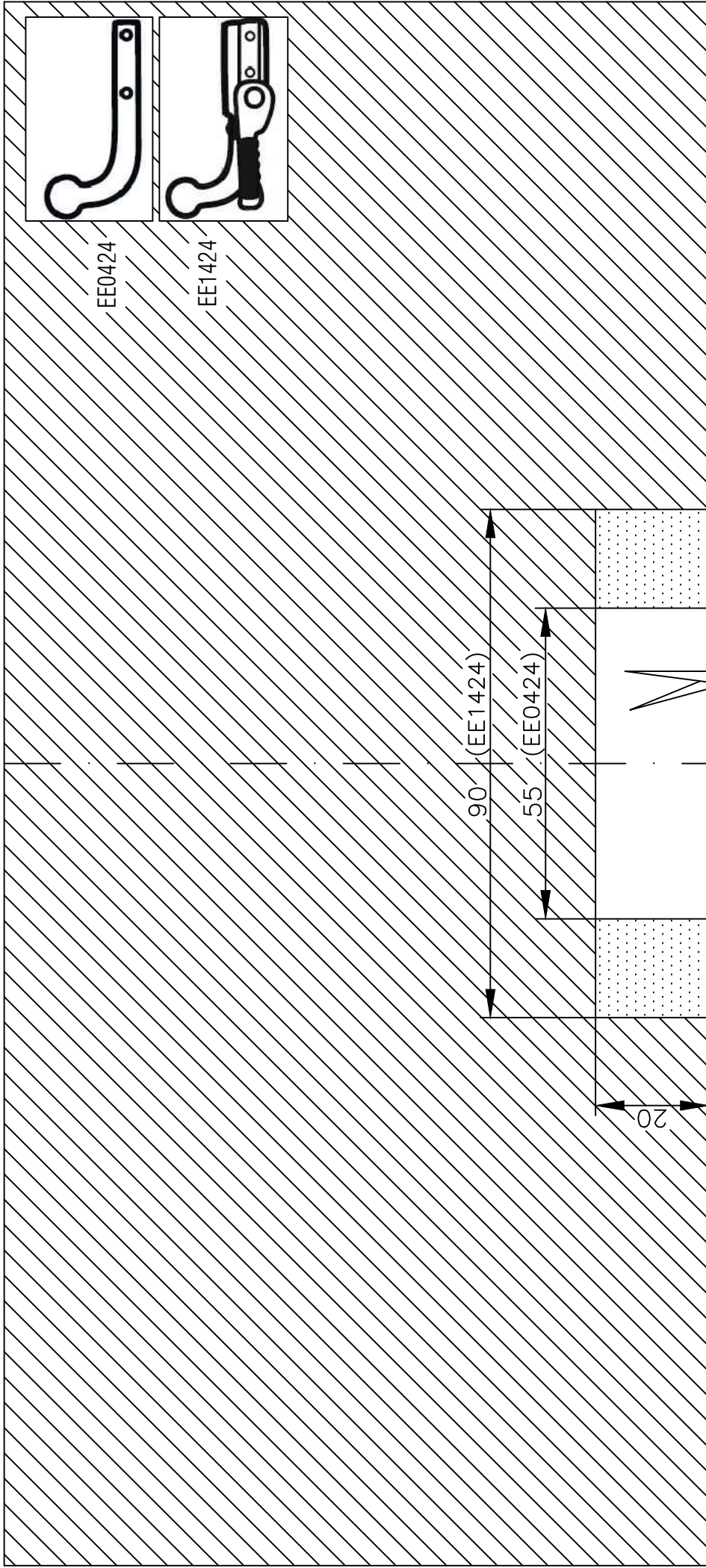

LÍNEA CENTRAL DEL PARAGOLPES

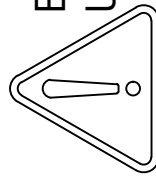

ESP: El corte es orientativo puede variar por modelo y año
 UK: The cut is indicative it can change for model and year



Escala: 1:1
 UNIDADES EN mm

Dibujo: CORTE PARAGOLPES
 CITRÖEN C3 PICASSO

EE0424-EE1424
 Rev. P1