

AUDI Q3  
SEAT TARRACO  
SKODA KODIAQ  
VW TIGUAN II

**NOTA**

AUDI Q3  
VW TIGUAN II  
SEAT TARRACO

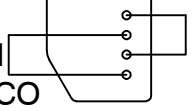

SKODA KODIAQ

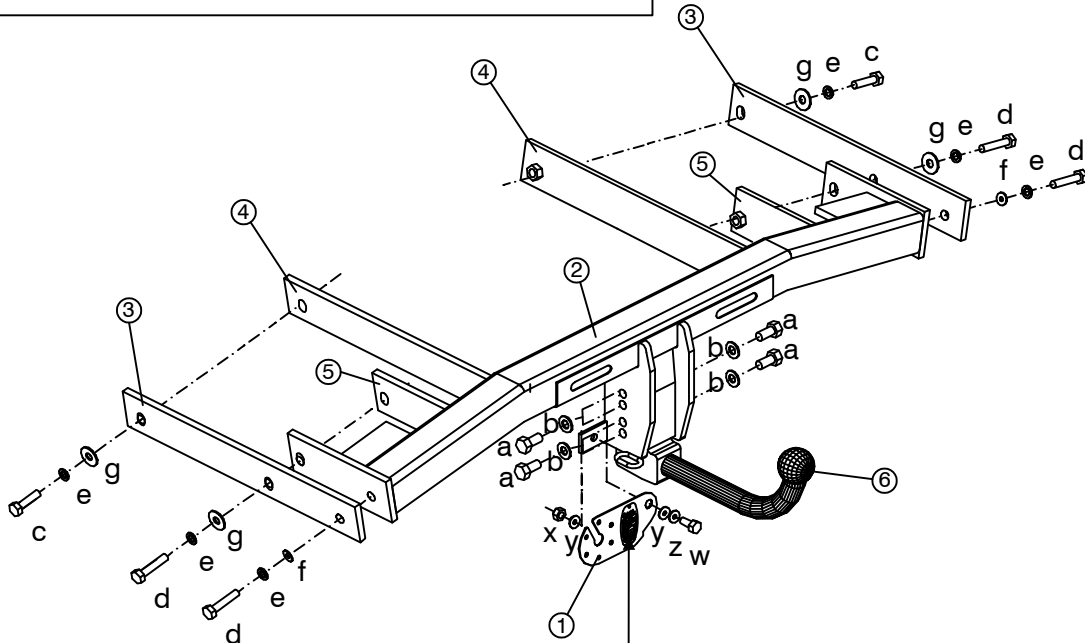



Made by LAFUENTE (SPAIN)  
Tf. (+34) 952 625 840  
www.lafuente.eu

**Eg** 55R -01 2225

TIPO EE4495 D 12,28 kN  
CLASE A-50X S 100 kg

Número de homologación / Approval No:  
**E9\*55R01/07\*2225\*02**











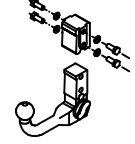

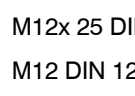
Comprobar en el Certificado de Conformidad (COC) del vehículo las capacidades máximas de arrastre y carga vertical.  
See the Certificate Of Conformity (COC) of your vehicle or contact your dealer to verify the max. trailer weight of your car!

M.M.R. 	S 	D
2.500 kg.	100 kg.	12,28 kN



ECE R55  
homologación

ELEMENTOS DE UNIÓN / CONNECTION COMPONENTS  
DAZUGEHÖRENENDEN TEILEN / ÉLÉMENTS DE RACCORD

BOLA / BALL / KUGEL / BOULE		VEHÍCULO / VEHICLE FAHRZEUG / VÉHICULE	
		c  2 x M12x40 DIN 933	8.8
		d  4 x M12x50 DIN 933	8.8
		e  6 x M12 DIN 6798	8
		f  2 x M12 DIN 125	-
a  4 x M12x 25 DIN 933	8.8	g  4 x M12 DIN 9021	-
b  4 x M12 DIN 127	-	w  1 x M10x30 DIN 933	8.8
		x  1 x M10 DIN 985	8
		y  2 x M10 DIN 125	-
		z  1 x M10 DIN 2093	-

Par de apriete para los tornillos/Tightening torque for bolts/Schrauben Drehmoment/Couple de serrage pour vis

Und.Nm	M6	M8	M10		M12			M14		M16	
calidad	peso	1	1,25	1,5	1,25	1,75	1,5	1,25	1,75	1,5	2
8.8	11,3	27,3	54,0	57,0	93,0	97,0	101,0	148,0	159,0	230,0	
10.9	16,5	40,1	79,0	83,0	137,0	143,0	149,0	218,0	234,0	320,0	
12.9	19,3	46,9	93,0	98,0	160,0	167,0	174,0	255,0	274,0	395,0	

Este documento debe ser presentado en la I.T.V. junto con el certificado de montaje.

HNOS.SÁNCHEZ-LAFUENTE,S.A. no asume ningún tipo de responsabilidad por daños causados por usos inadecuados.

Nº Rev: 02 Aprobado: 13-01-2020



EE4495



# AUDI Q3

## SEAT TARRACO

## SKODA KODIAQ

## VW TIGUAN

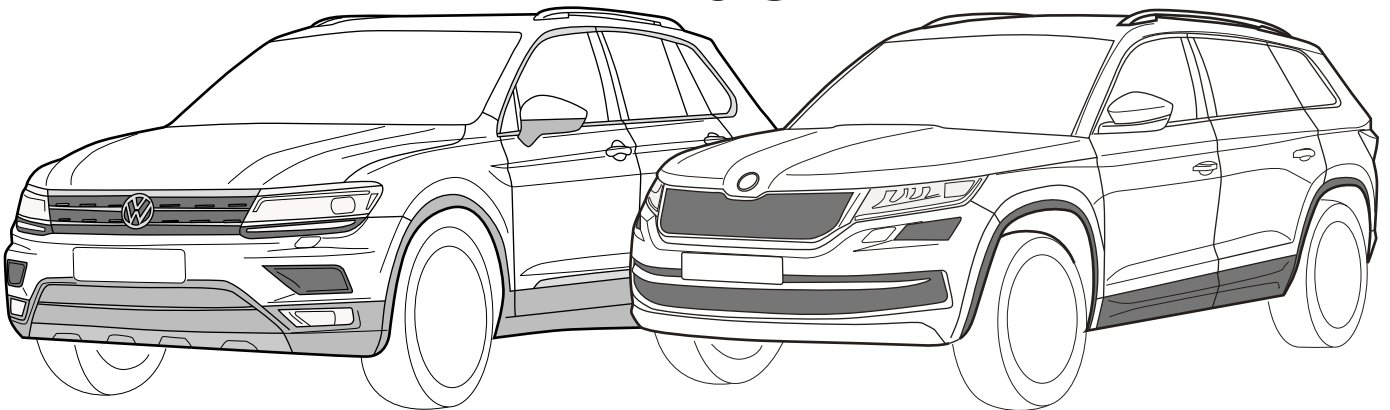

Instrucciones de montaje - Installation instructions - Notice de montage - Montage- og driftsvejledning

1

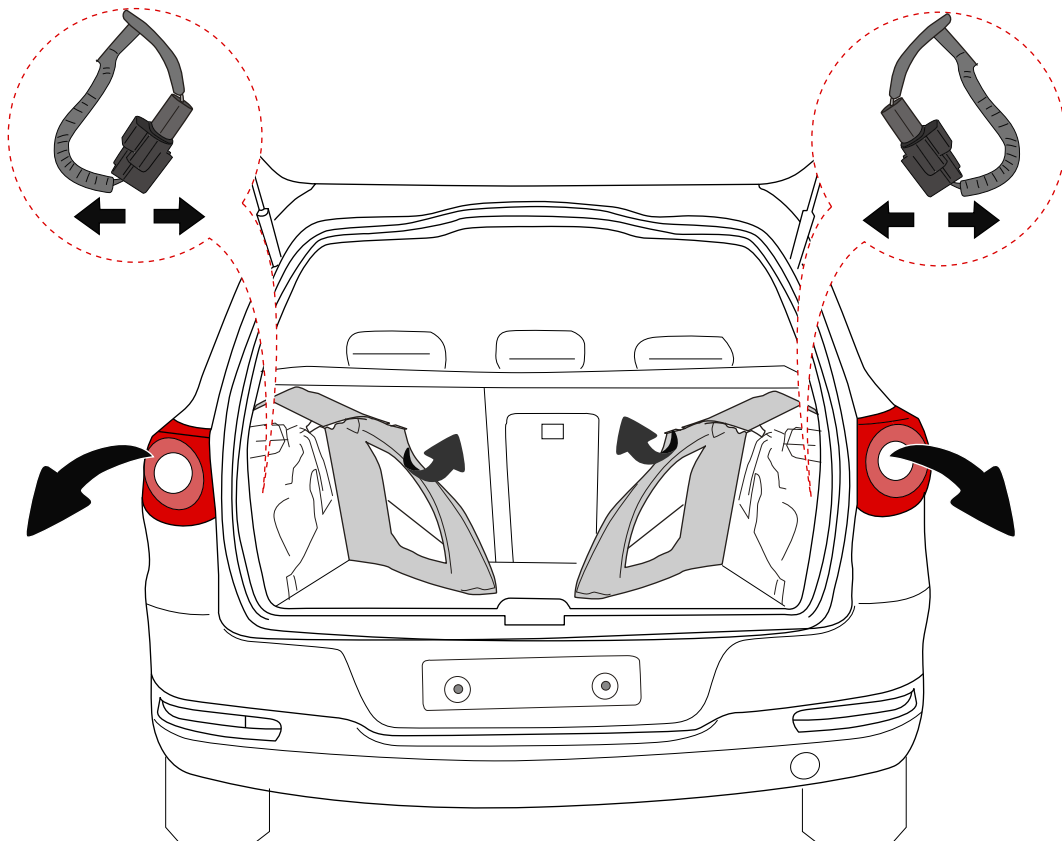

2

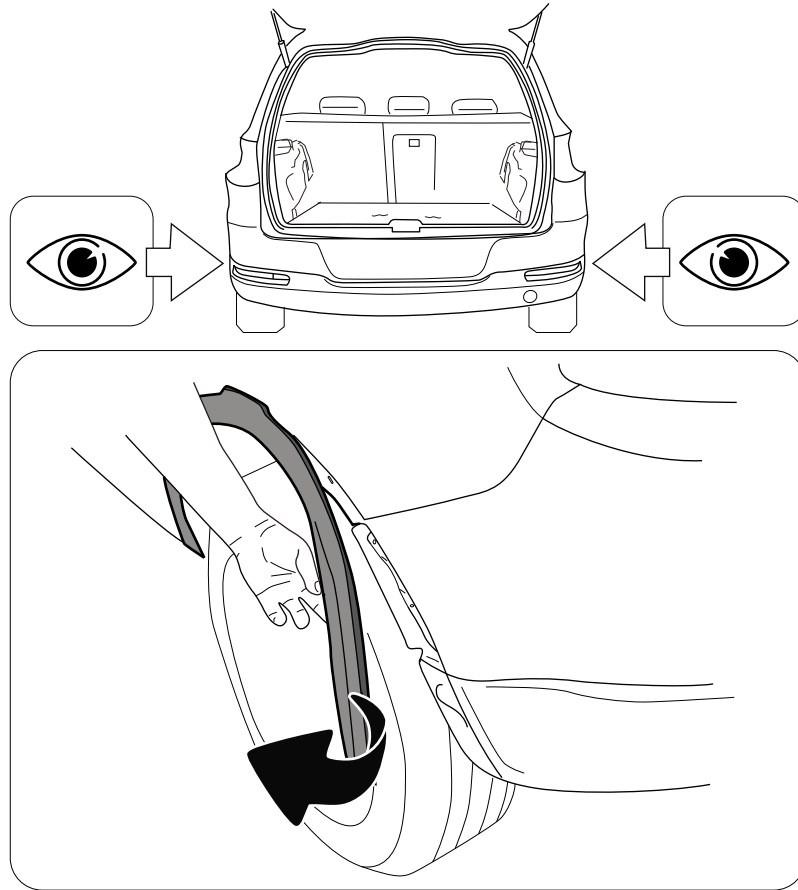

3

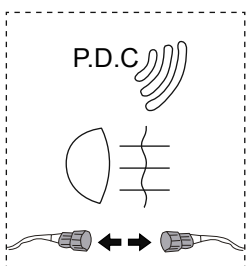
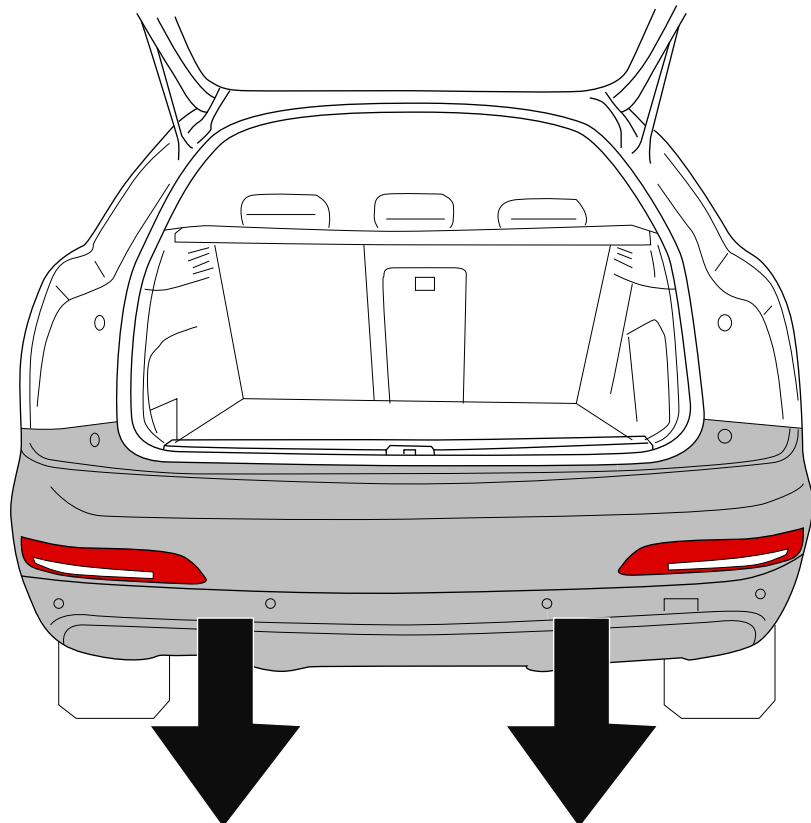

4

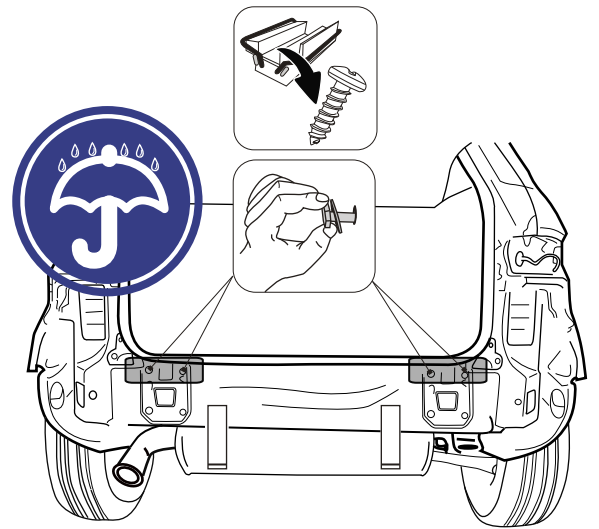
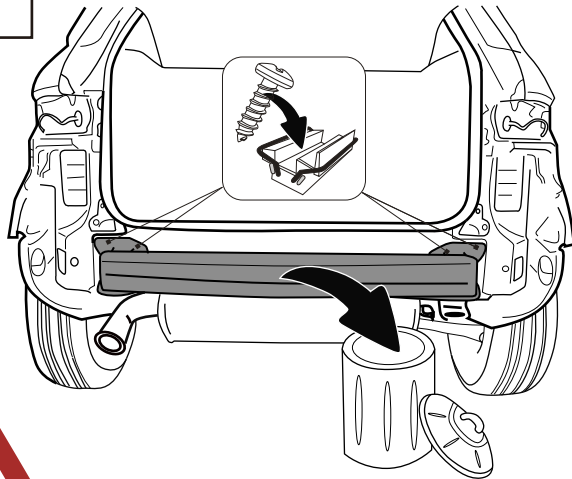

SKODIA KODIAQ  
VW TIGUAN II  
Adblue

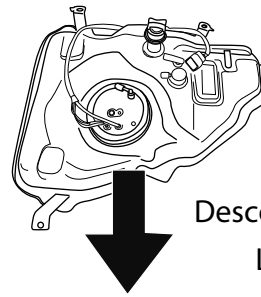
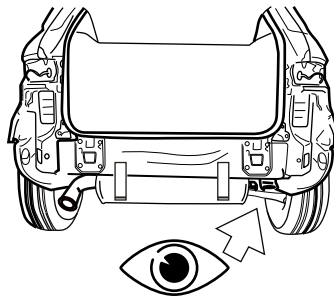

Descolgar deposito Adblue  
Lift Adblue tank

5

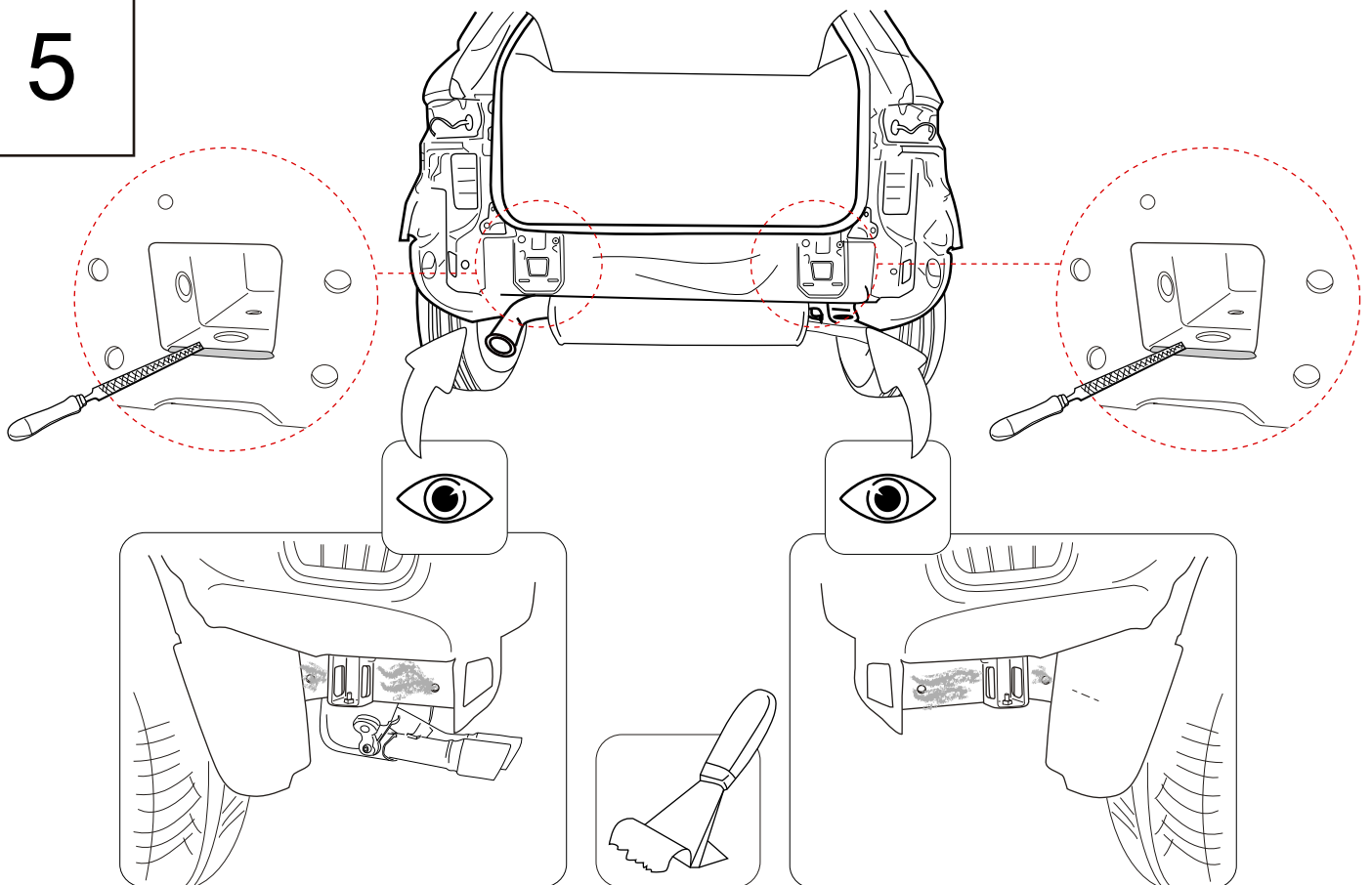

6

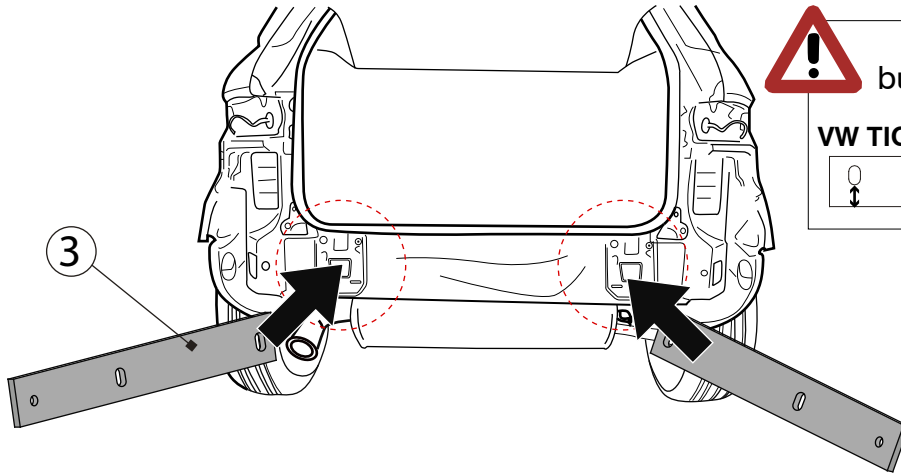

colocación pieza 3  
buscar mayor distancia

VW TIGUAN II/SKODA KODIAQ

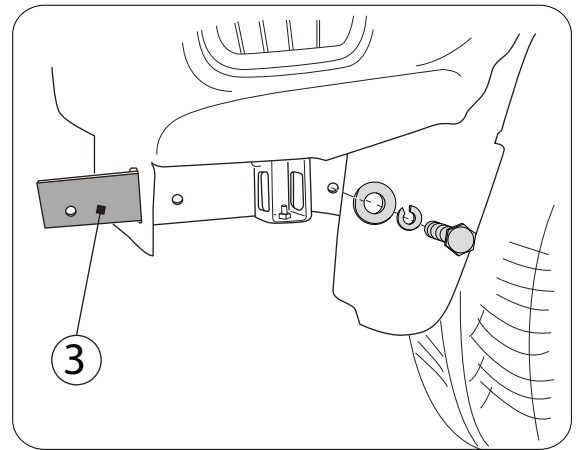
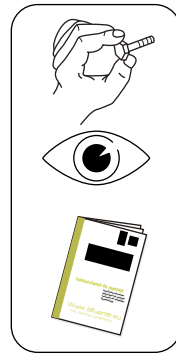
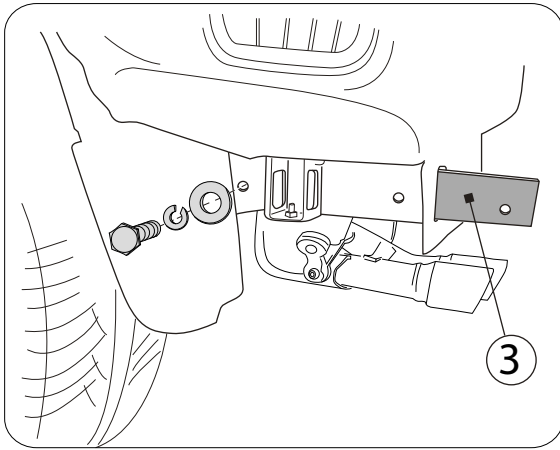

7

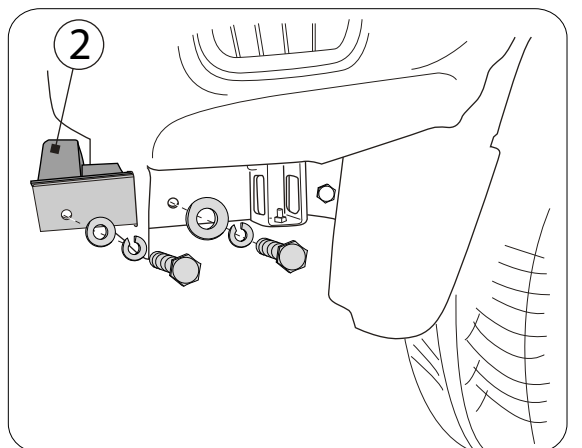
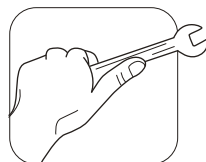
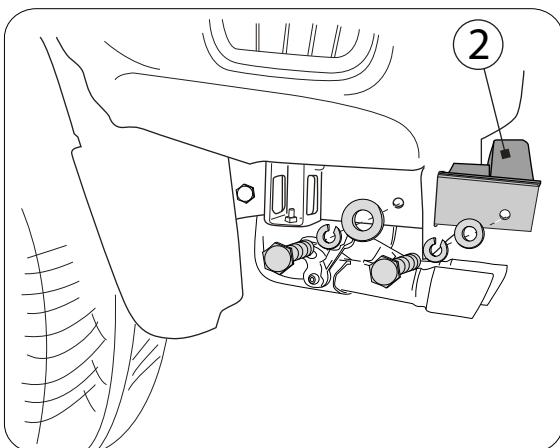
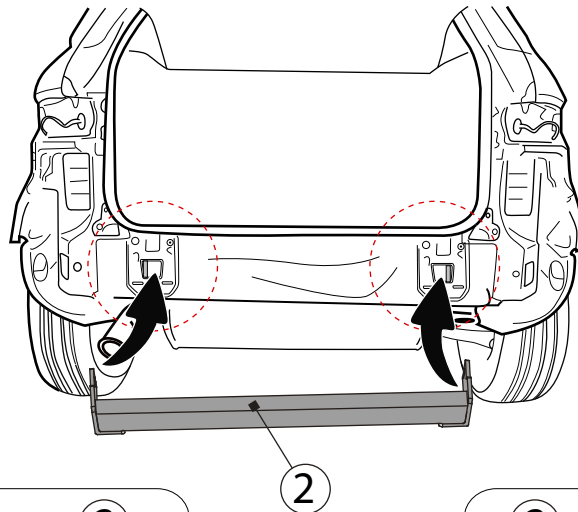
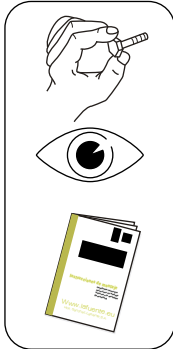

8

SKODA KODIAQ VW TIGUAN II

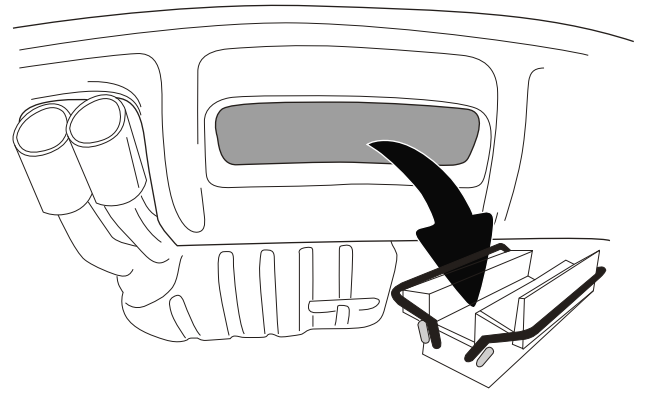
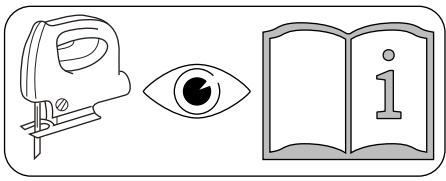
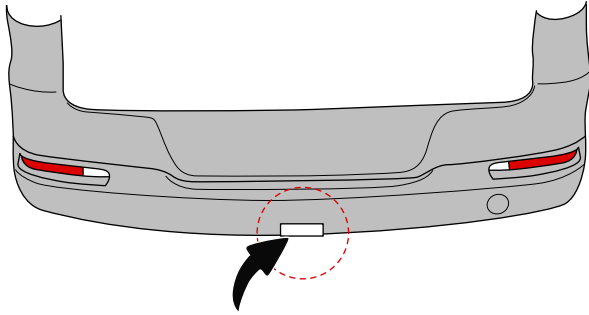

9

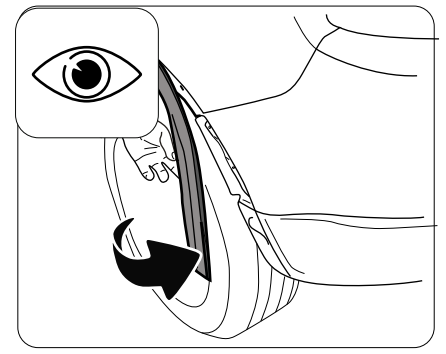
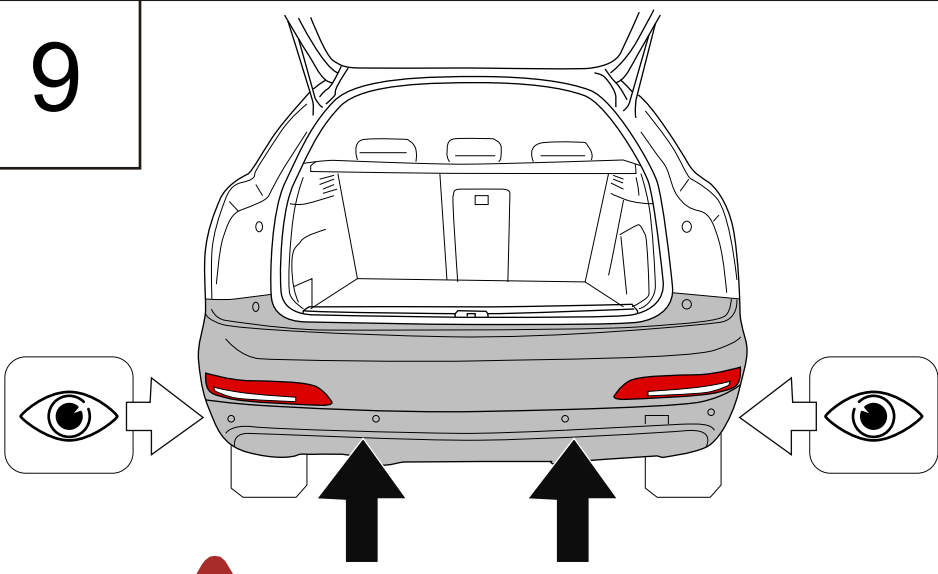

SKODIA KODIAQ  
VW TIGUAN II  
Adblue

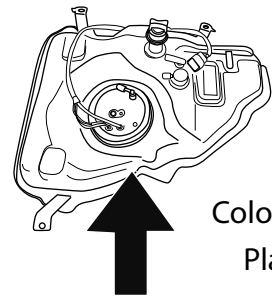
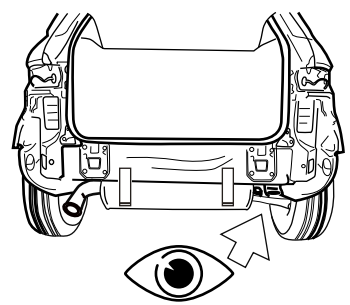

Colocar deposito Adblue  
Place Adblue tank

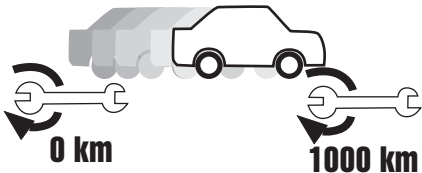
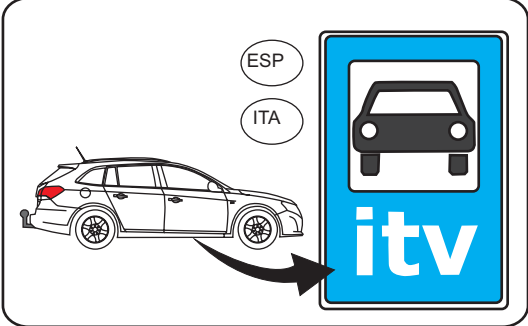
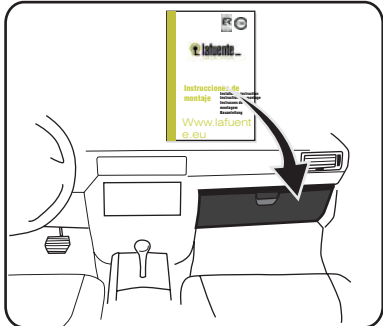
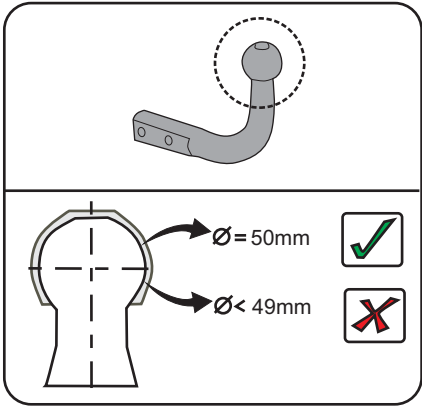
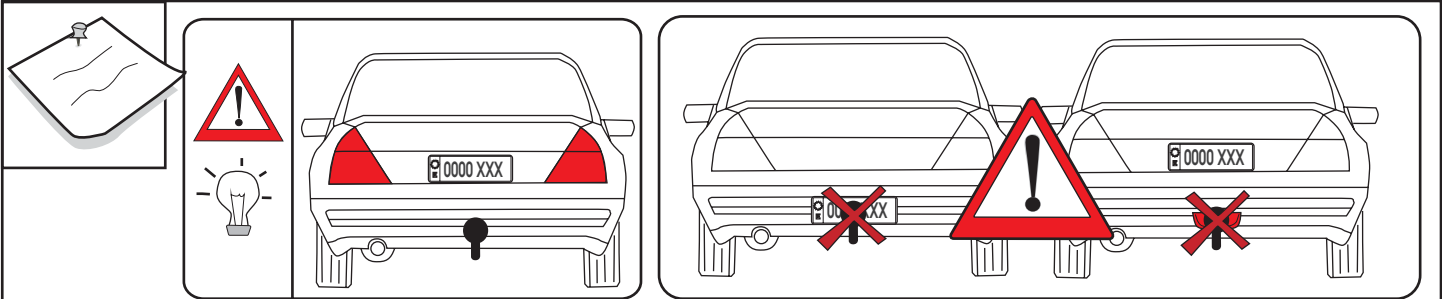
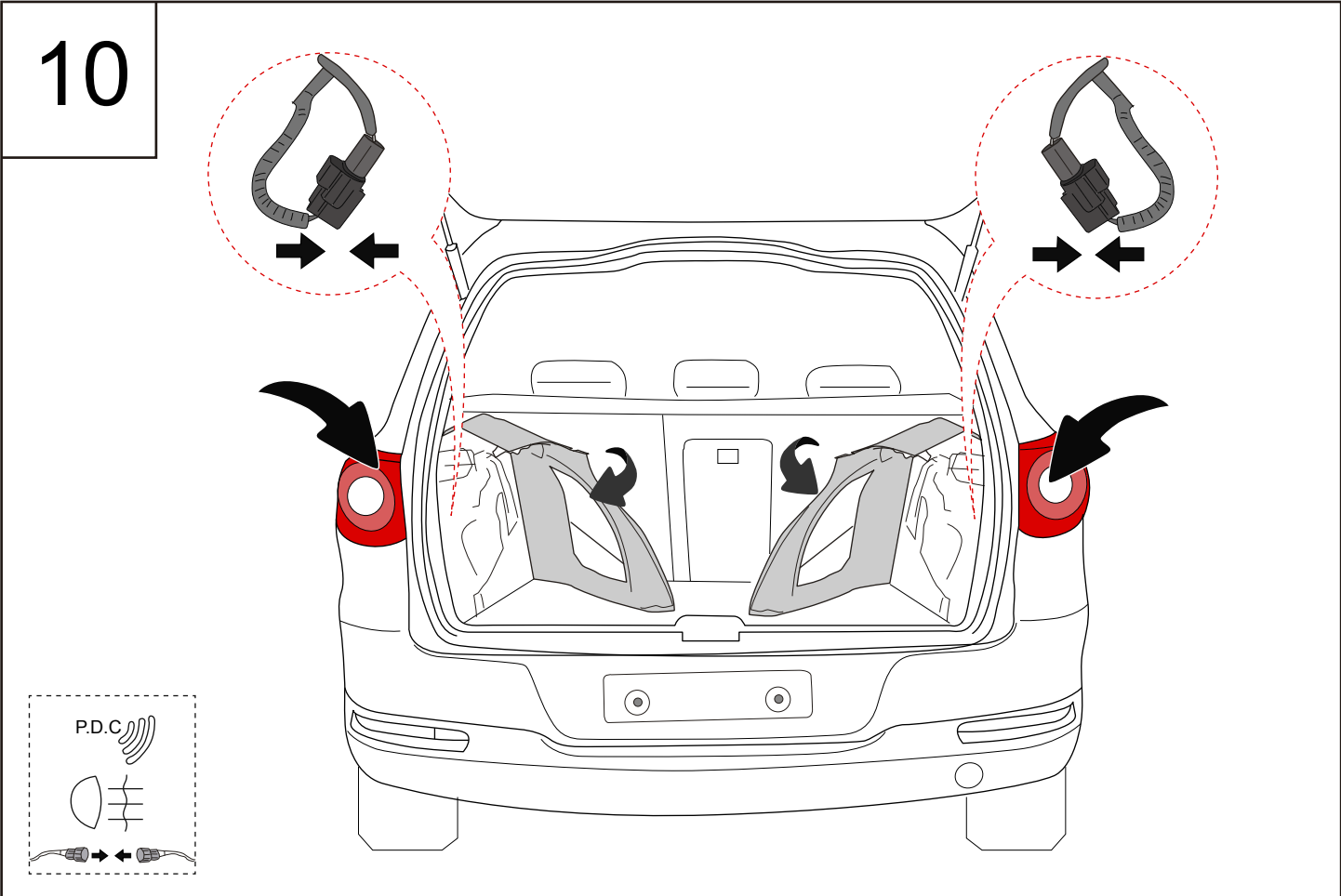

	M6	M8	M10	M12	M14	M16
8.8	10,4Nm	25,0Nm	51,0Nm	87,0Nm	140,0Nm	215,0Nm
10.9	15,5Nm	37,0Nm	75,0Nm	130,0Nm	205,0Nm	310,0Nm
12.9	18,0Nm	43,0Nm	87,0Nm	150,0Nm	240,0Nm	370,0Nm