

KIA SPORTAGE

S		D
125 kg.		11,56 kN



ECE R55
homologación

PIEZA DEL PARAGOLPES DEL VEHICULO

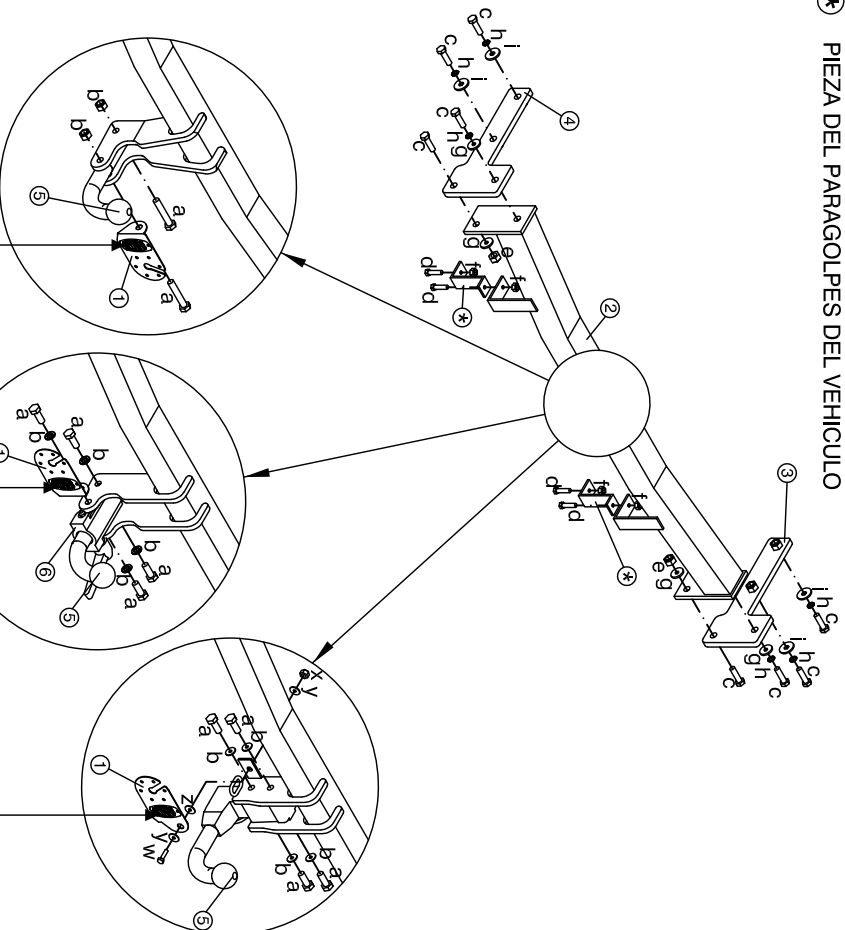

Made by LAFUENTE

 SRTL / (SPANISH) cert. sin
 www.lafuente.eu

TIPO E9 EF0627 55R -XX XXXX D 11,56 kN S 125 kg
 CLASE A-50X























Made by LAFUENTE

 SRTL / (SPANISH) cert. sin
 www.lafuente.eu

TIPO E9 EE1627 55R -XX XXXX D 11,56 kN S 125 kg
 CLASE A-50X

Made by LAFUENTE

 SRTL / (SPANISH) cert. sin
 www.lafuente.eu

TIPO E9 EF4627 55R -XX XXXX D 11,56 kN S 125 kg
 CLASE A-50X

ELEMENTOS DE UNIÓN / CONNECTION COMPONENTS	
DAZUGEHÖRENDENDEN TEILEN / ÉLÉMENTS DE RACCORD	
BOLA / BALL / KUGEL / BOULE	VEHÍCULO / VEHICLE FAHRZEUG / VÉHICULE

a		2 x M12x65 DIN 931	8,8	c		8 x M12x40 DIN 933	8,8
b		2 x M12 DIN 985	8	d		4 x M6x16 DIN 6921	8,8
a		4 x M12x25 DIN 933	8,8	e		2 x M12 DIN 985	8
b		4 x M12 DIN 125	-	f		4 x M6 DIN 6923	8
				g		4 x M12 DIN 125	-
				h		6 x M12 DIN 6798	-
				i		4 x M12 DIN 9021	-
a		4 x M12x25 DIN 933	8,8	w		1 x M10x30 DIN 933	8,8
b		4 x M12 DIN 127	-	x		1 x M10 DIN 985	8
				y		2 x M10 DIN 125	-
				z		1 x M10 DIN 2093	-

Par de apriete para los tornillos/Tightening torque for bolts/Schrauben Drehmoment/Couple de serrage pour vis

Und.Nm	M6	M8	M10	M12	M14	M16
calibre	1	1,25	1,5	1,25	1,75	2
8,8	11,3	27,3	54,0	97,0	101,0	148,0
10,9	16,5	40,1	79,0	137,0	143,0	159,0
12,9	19,3	46,9	93,0	160,0	174,0	230,0
						320,0
						395,0

Este documento debe ser presentado en la I.T.V. junto con el certificado de montaje.

HERMANOS SÁNCHEZ-LAFUENTE,S.A. no asume ningún tipo de responsabilidad por daños causados por usos inadecuados.

Nº Rev: 00 Aprobado: 21-06-2022

Comprobar en el Certificado de Conformidad (COC) del vehículo las capacidades máximas de arrastre y carga vertical.
 See the Certificate Of Conformity (COC) of your vehicle or contact your dealer to verify the max. trailer weight of your car!



KIA SPORTAGE



EE0627



EE1627



EE4627

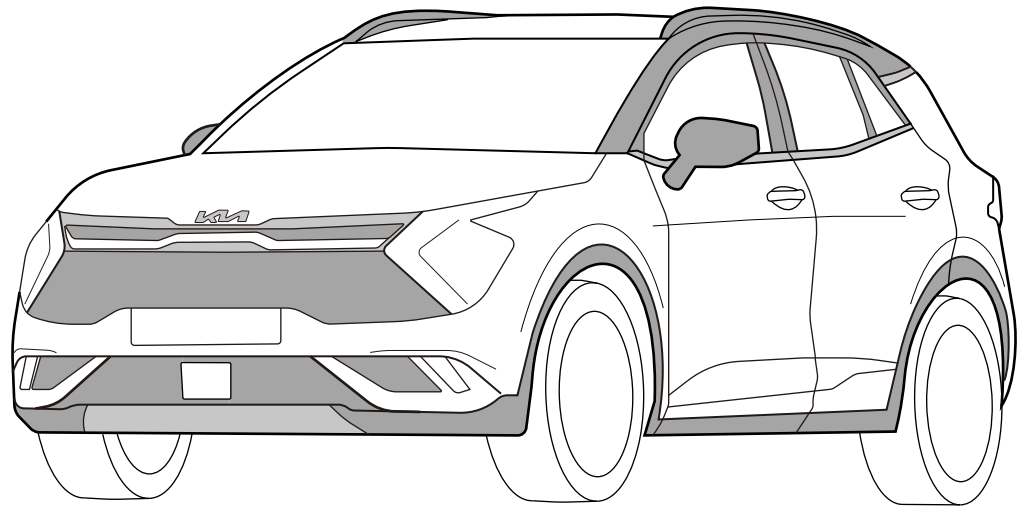

Instrucciones de montaje - Installation instructions - Notice de montage - Montageanleitung

1

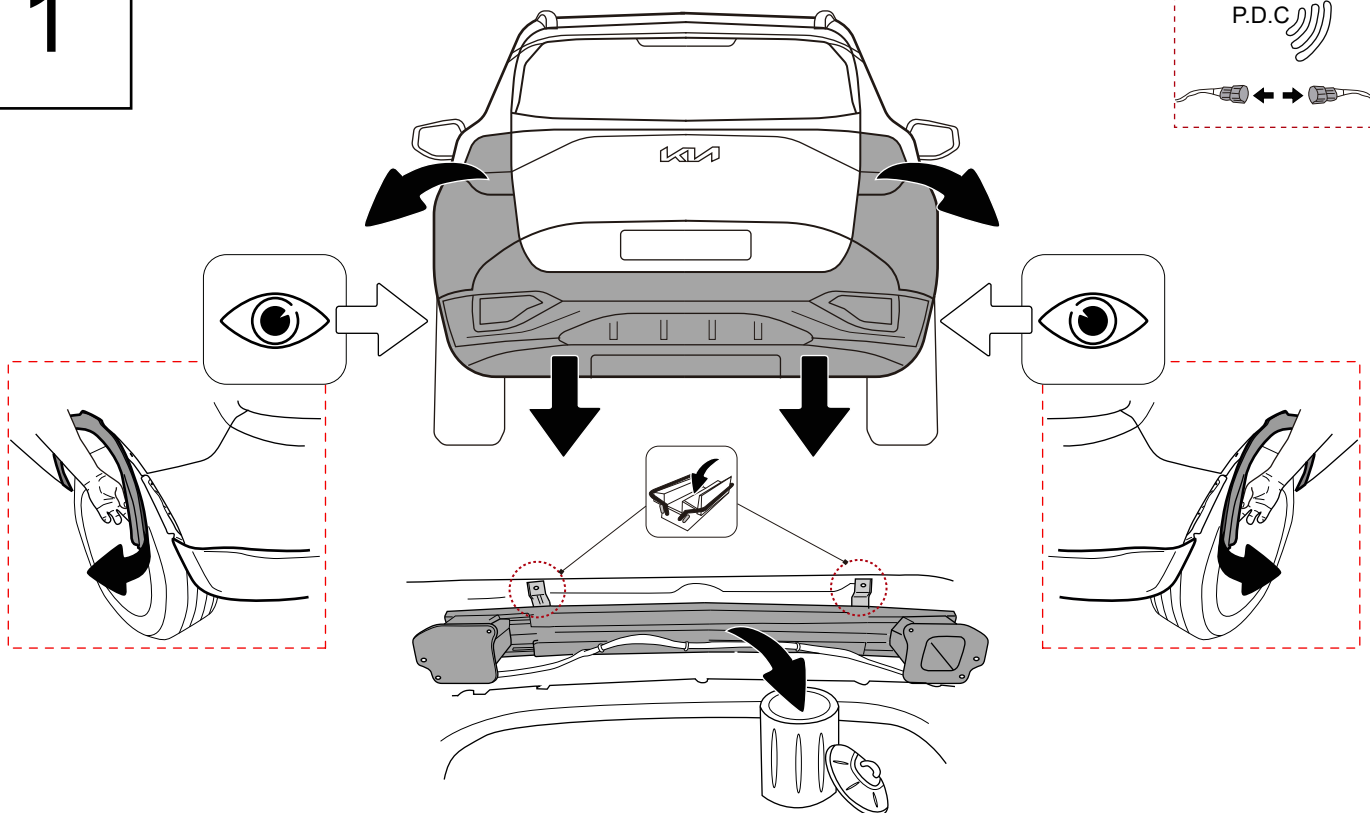
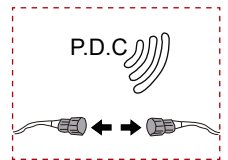

2

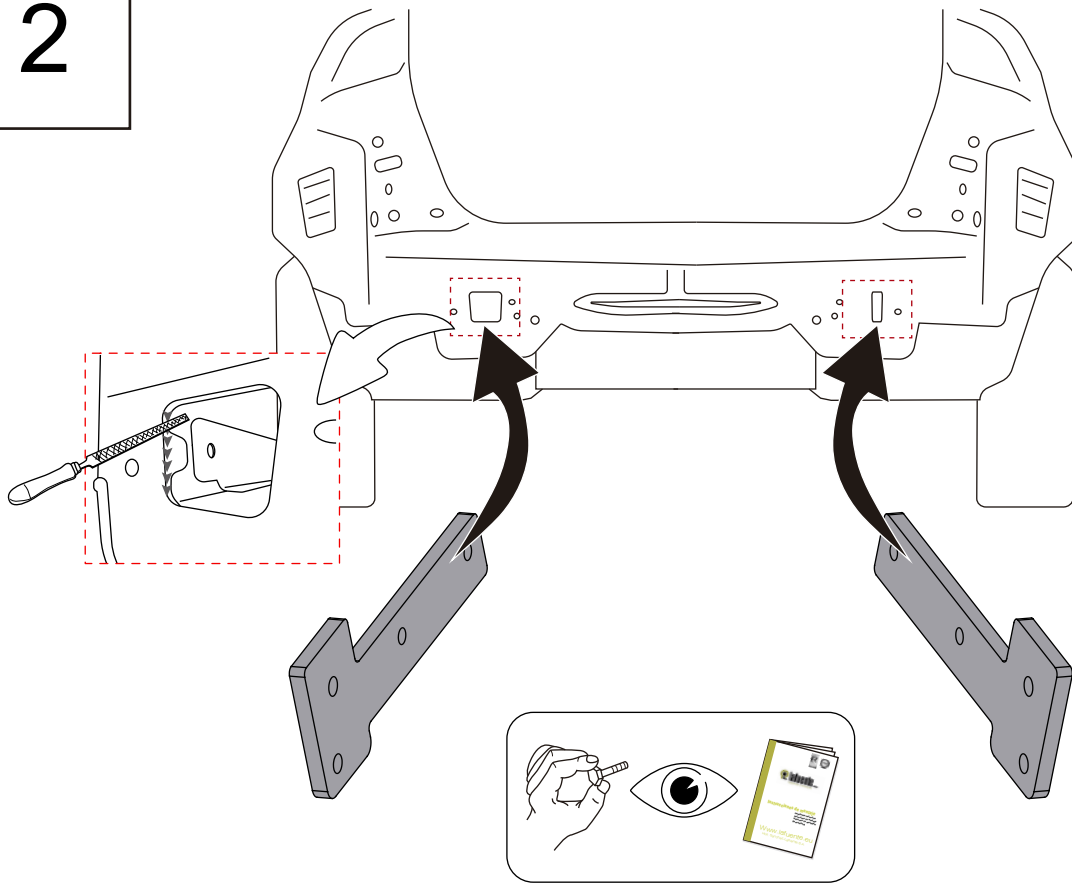

3

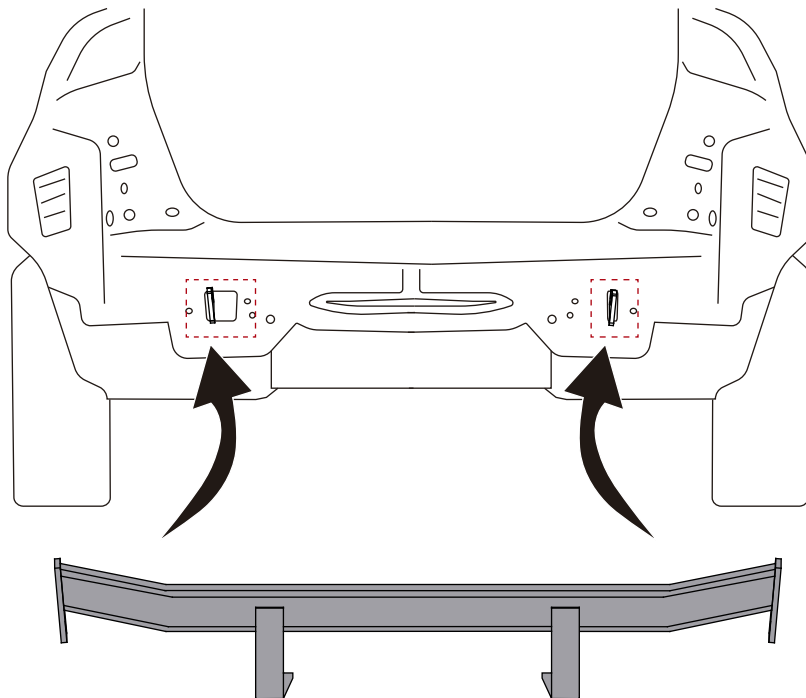

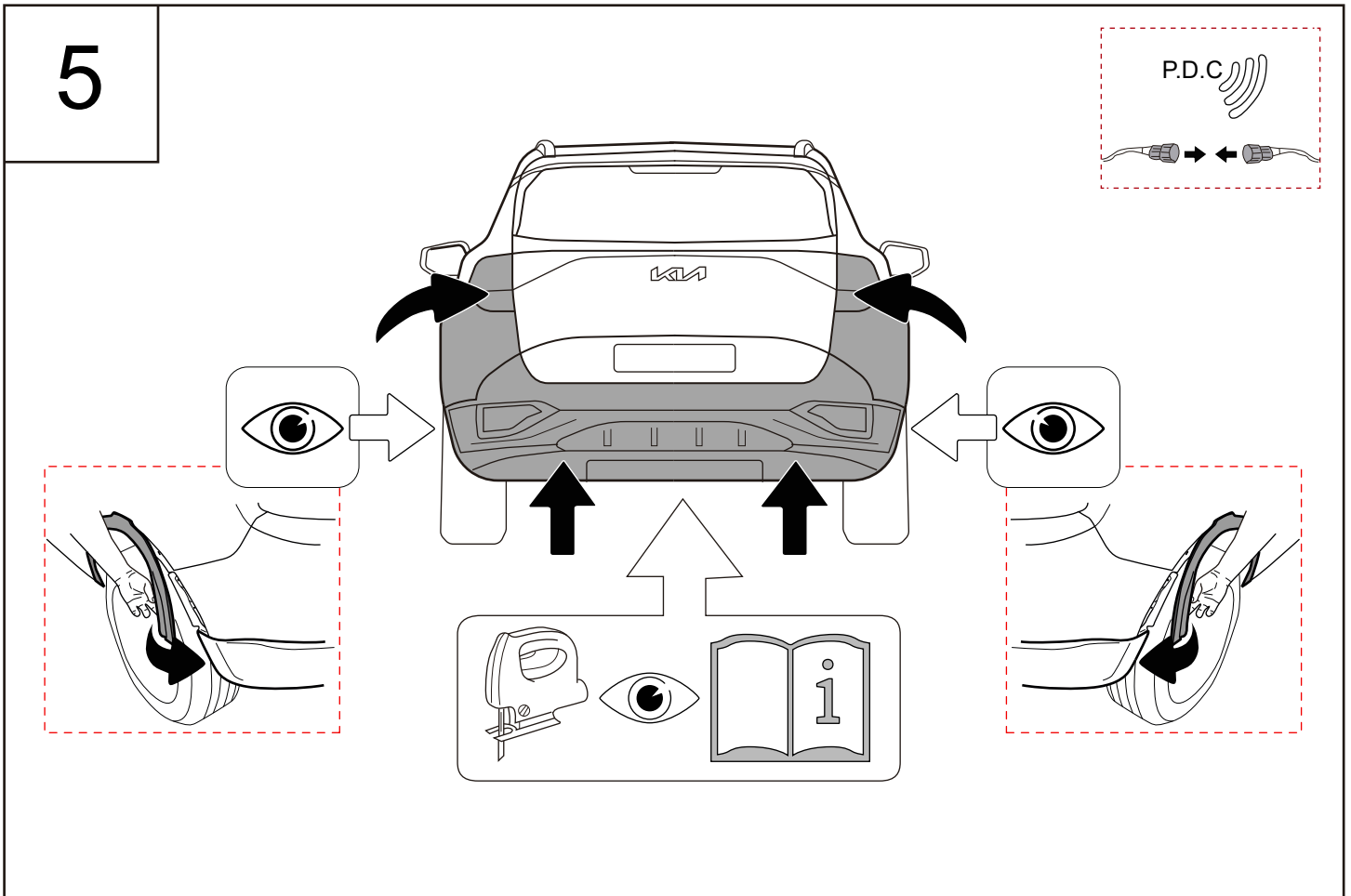
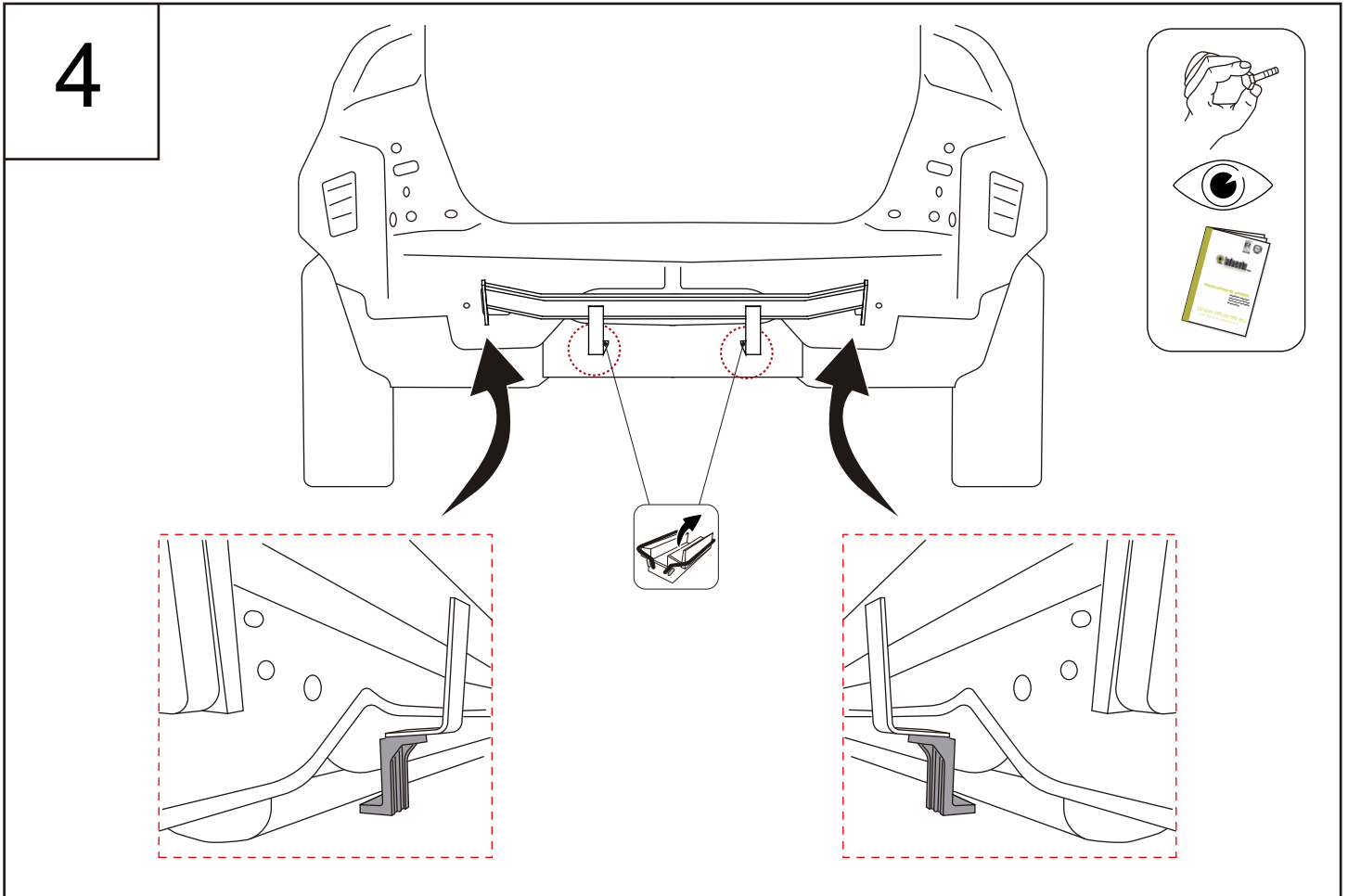

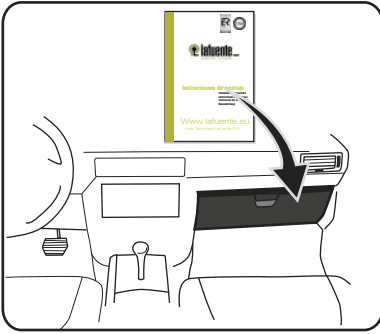
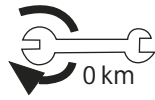

	M6	M8	M10	M12	M14	M16
8.8	10,4Nm	25,0Nm	51,0Nm	87,0Nm	140,0Nm	215,0Nm
10.9	15,5Nm	37,0Nm	75,0Nm	130,0Nm	205,0Nm	310,0Nm
12.9	18,0Nm	43,0Nm	87,0Nm	150,0Nm	240,0Nm	370,0Nm

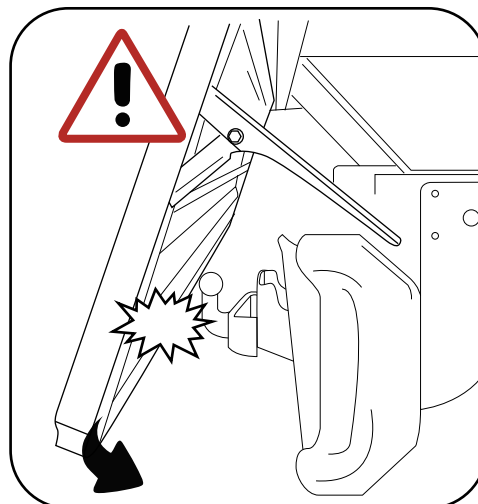
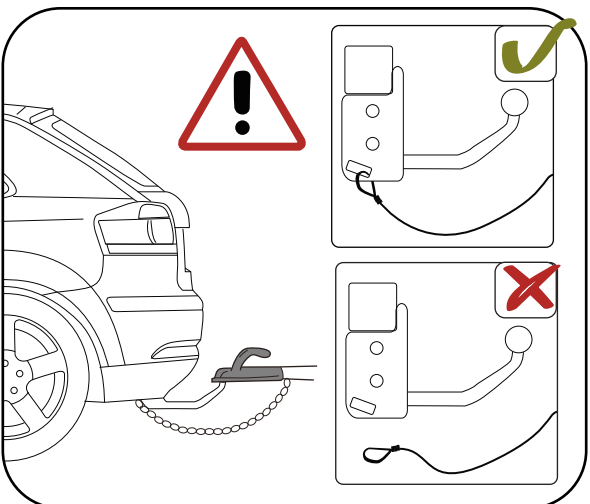
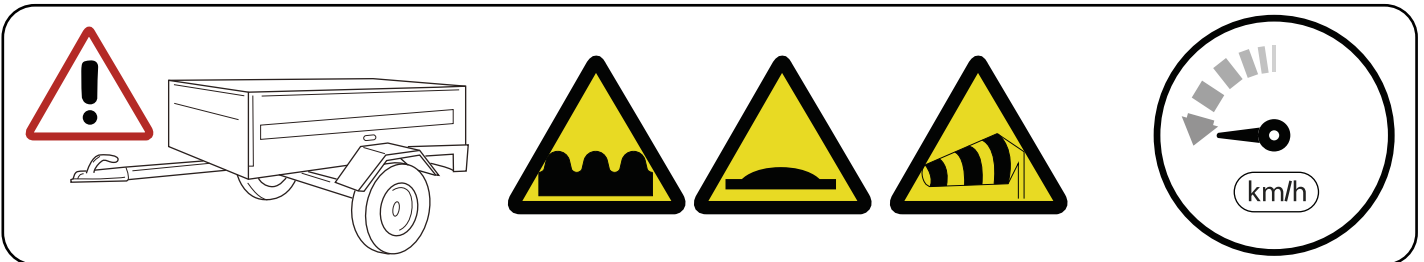
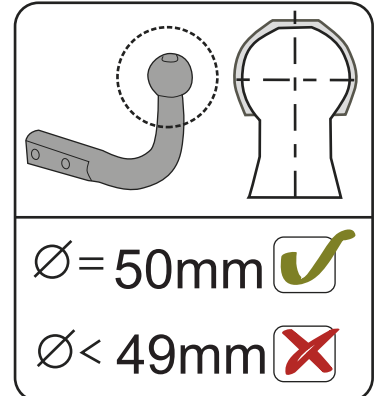
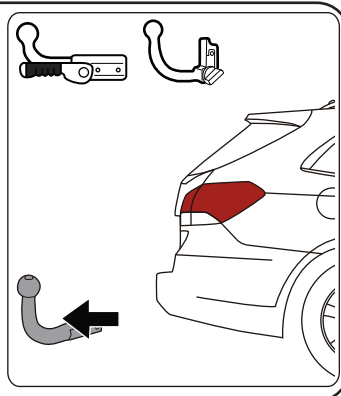
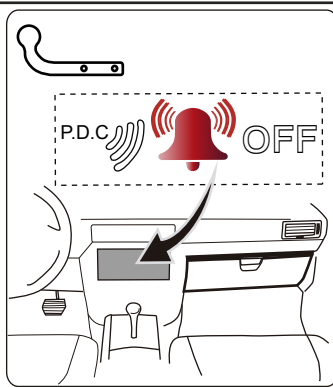
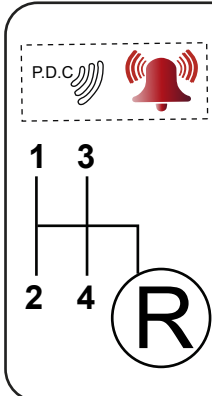
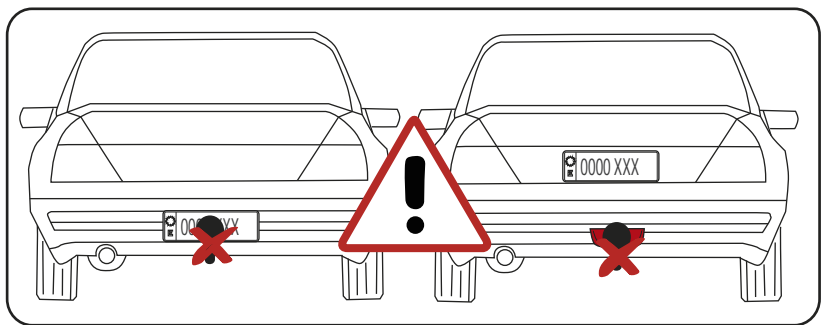
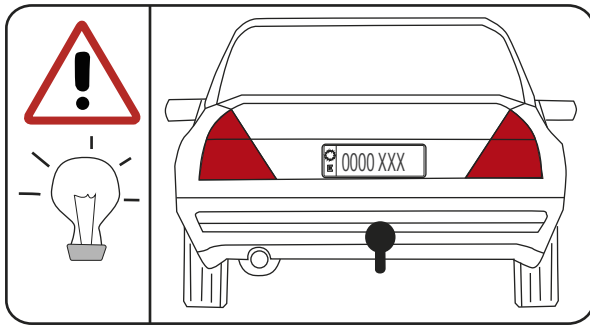

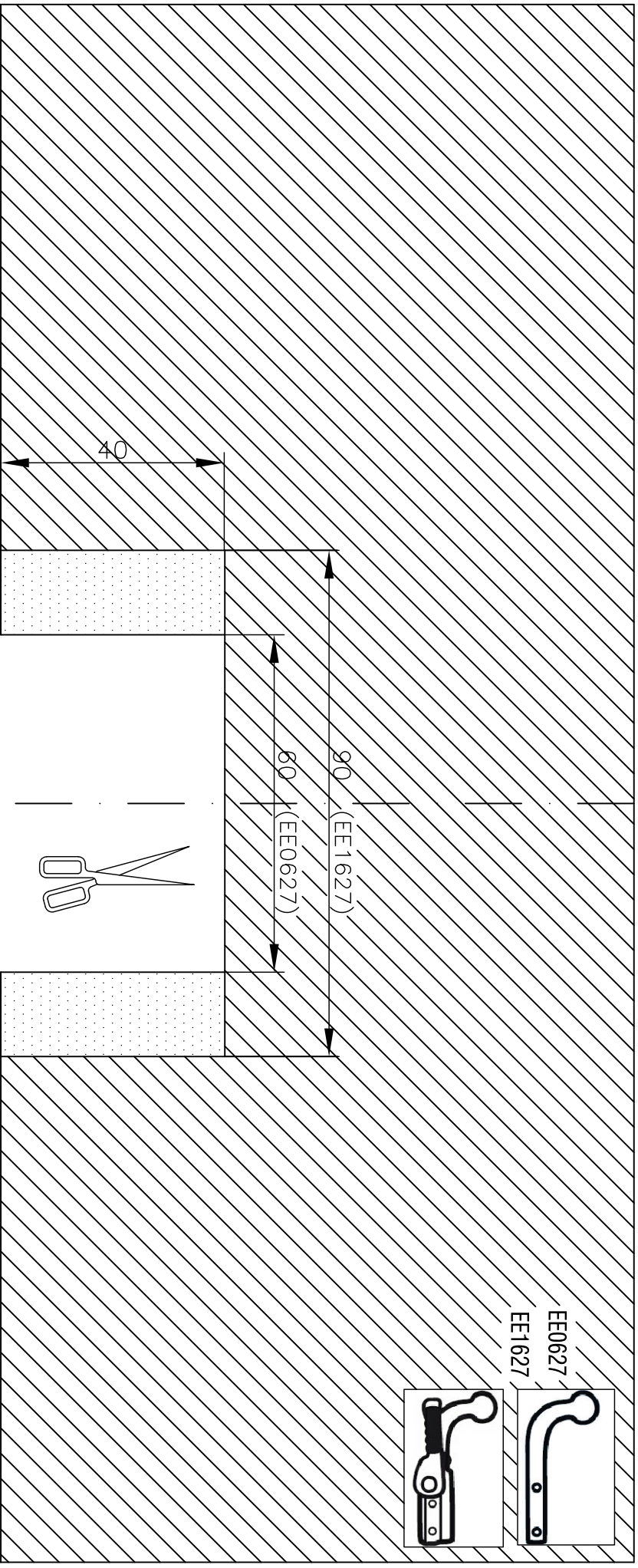

LINEA CENTRAL DE LA CARCASA

BUMPER CENTRAL LINE

ESP: El corte es orientativo puede variar por modelo y año
 UK: The cut is indicative it can change for model and year

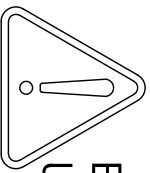

Dibujo:
 CORTE CARCASA PARAGOLPES
 KIA SPORTAGE

Escala:
 1:1 UNIDADES EN
 mm

EE0627-EE1627

Rev.
 P1



EE4627

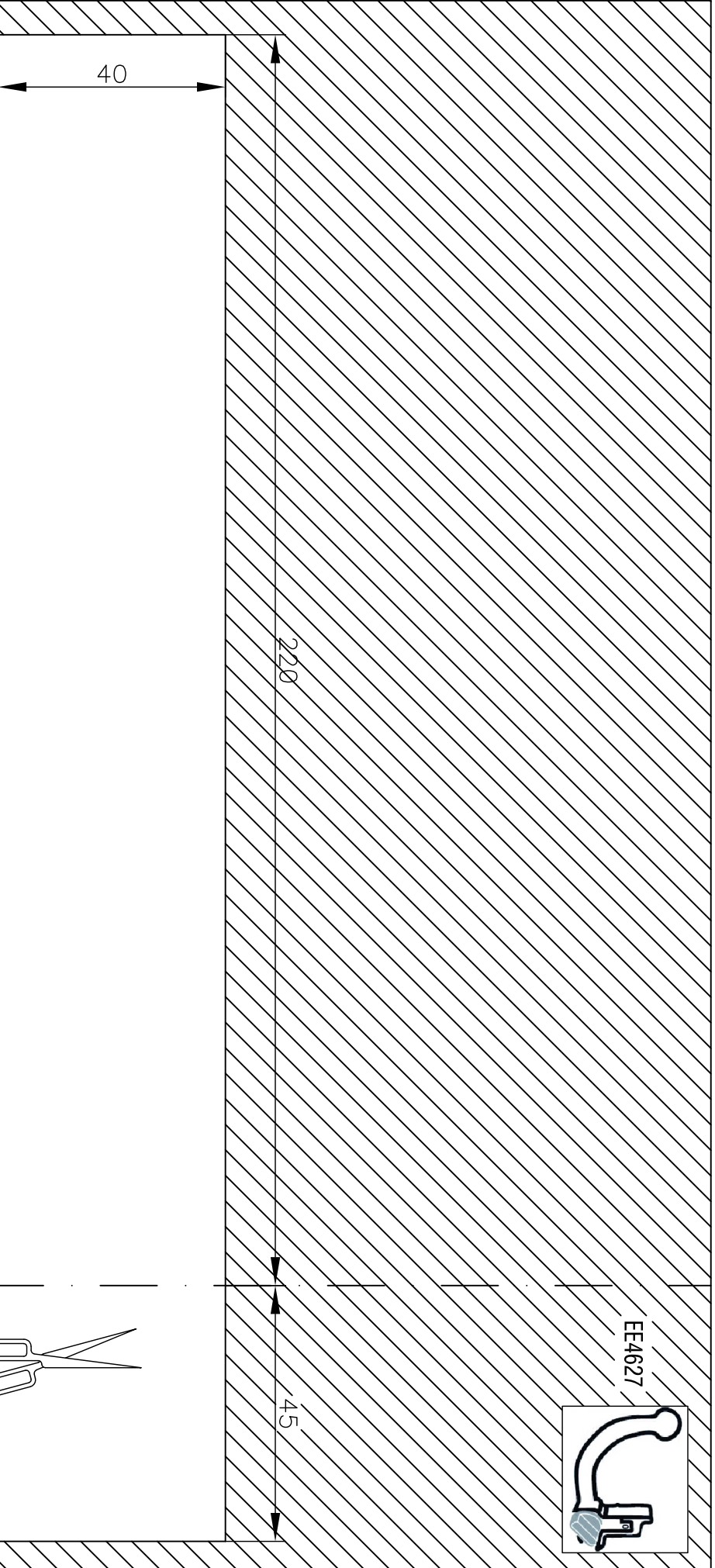

LÍNEA CENTRAL DE LA CARCASA
BUMPER CENTRAL LINE

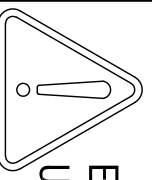

ESP: El corte es orientativo puede variar por modelo y año
UK: The cut is indicative it can change for model and year



Escala: 1:1
UNIDADES EN mm

Dibujo: CORTE CARCASA PARAGOLPES
KIA SPORTAGE

EE4627
Rev. P1